

AM · FM · TELEVISION

BROADCAST

NEWS



1947 N.A.B. CONVENTION ISSUE



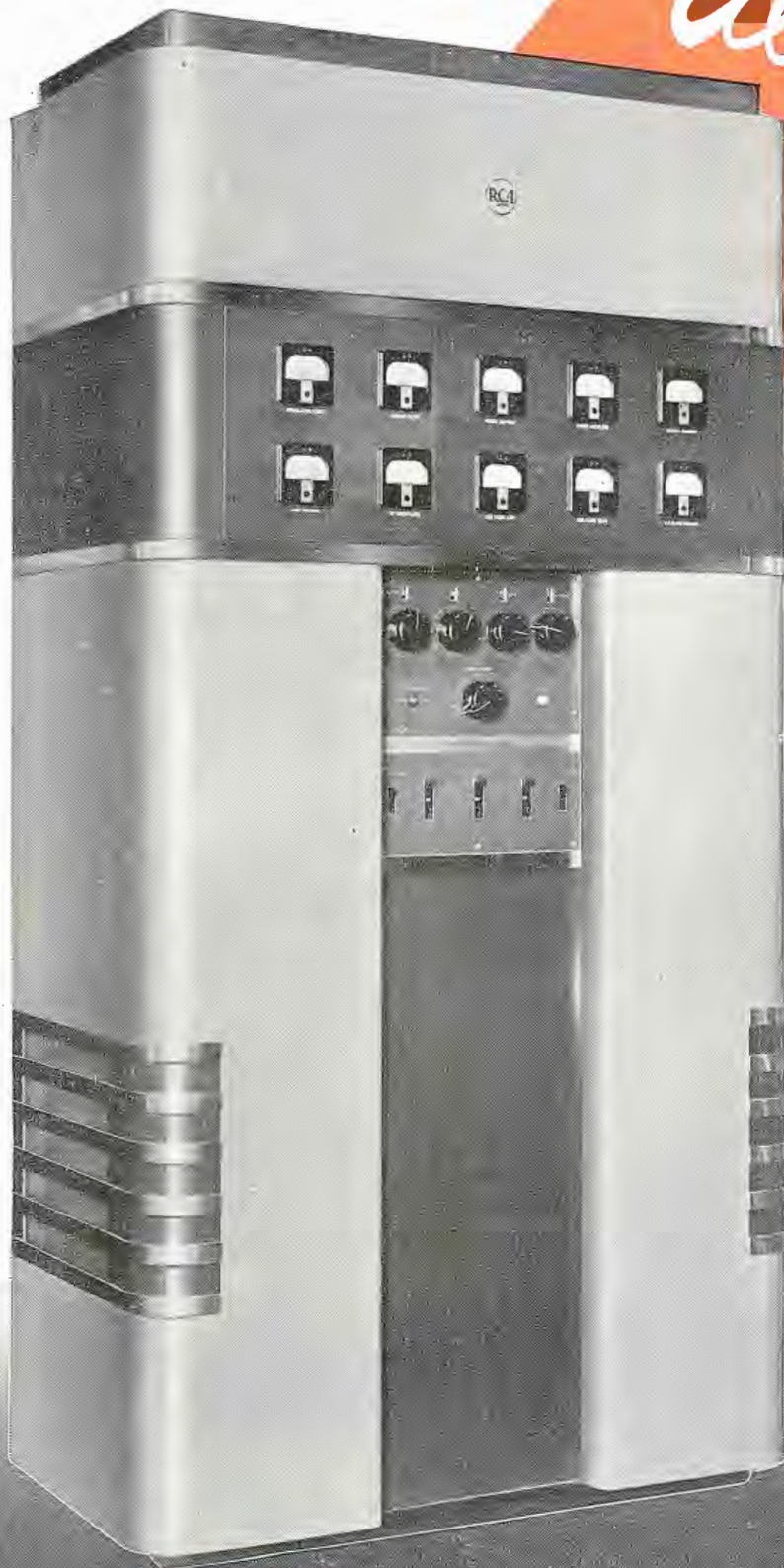

**America's favorite
250-watt AM transmitter
model BTA-250-L**

WITH OPERATING FEATURES as familiar to broadcast engineers as station call letters, RCA 250-watt AM transmitters . . . more than 350 of them . . . have been making close friends with station owners since 1940.

Need we say more?

See your RCA Broadcast Sales Engineer, or write RCA, Broadcast Equipment Section, Department 19-G, Camden, New Jersey.



**BROADCAST EQUIPMENT
RADIO CORPORATION of AMERICA
ENGINEERING PRODUCTS DEPARTMENT, CAMDEN, N.J.**

In Canada: R C A V I C T O R Company Limited, Montreal

Broadcast News

AM • FM • TELEVISION

Published by the

RADIO CORPORATION OF AMERICA

ENGINEERING PRODUCTS DEPARTMENT . . . CAMDEN, NEW JERSEY

NUMBER 46

SEPTEMBER, 1947

Subscription Rate \$1.50 per year.

Single copy 50c.

JOHN P. TAYLOR, Editor

JUDY J. ALES, Ass't Editor

Contents

THE ATLANTIC CITY STORY	by JUDY J. ALES	4
NAB ENGINEERING CLINIC		9
HOW NAB USES THE RCA IMAGE ORTHICON CAMERA		
	by F. A. WANKEL AND E. C. WILBUR	12
WARNER BROTHERS AND RCA PLAN JOINT PROGRAM		
ON LARGE-SCREEN TELEVISION		21
THE NEWS OF THE HOUR STATION — WMIN	by FRANK M. DEVANEY	22
AT LAST — AN FM QUALITY SPEAKER	by G. E. RAND	24
FREQUENCY RANGE PREFERENCE FOR SPEECH AND MUSIC		
	by HARRY F. OLSON	28
RECORDING STUDIO 3A	by G. M. NIXON	33
KOOL IN ARIZONA		36
WFIL's TELEVISION PLANNING		38
THE RCA TYPE TJ-50A TELEVISION MOBILE UNIT		
	by W. J. POCH AND H. C. SHEPARD	44
TTR-1 AND TRR-1 TELEVISION RELAY UNITS		
TESTED OVER LONG DISTANCE		49
TOP ENGINEERS ATTEND TELEVISION COURSE	by E. B. MAY	50
A HIGH SCHOOL GOES FM	by JOHN W. STAHL	52
CAMERA PLACEMENT AND SWITCHING FOR		
BASEBALL TELECASTING	by JOHN P. TAYLOR	57

Copyright
Radio Corporation of America
RCA Victor Division
Camden, N. J.
Printed in U. S. A.

OUR COVER for this issue, as you can plainly see, is reproduced from a Kodachrome of Miss Terry Carroll (Miss Atlantic City for 1947) posing beside our new TK-10A Studio Camera—or didn't you see the camera? Credit for nice picture taking goes to Rod Allen of our own photographic department; for art and background, to Jack Parvin, director of our Art and Production Department; and for arrangements to Miss Judy Alesi, our hard-working Assistant Editor. And—we might add—a good time was had by all.

WFIL-TV has us almost at a loss for words. We're still rubbing our eyes. On June 5th the first part of their equipment was loaded on a truck in Camden. On the evening of August 6th—just 62 days later—WFIL-TV was on the air with test pattern. In this 62-day period the transmitter, control console, and five racks of auxiliary equipment were installed, wired and tested. Oh yes, they also tore down their prewar FM turnstile, removed 50 feet from their tower, substituted a new 3-bay super turnstile, installed transmission lines and connected the whole works together. Who said television would take years!

OLSEN DOES IT again, might be the title of Rex Rand's article (Page 24) heralding the long-awaited LC-1A Speaker. For to that most modest and gentlemanly of all Princeton sages, Dr. Harry F. Olson, goes the chief credit for a development which, at long last, really gives us a loudspeaker of true "FM quality" (i.e., uniform response and very low distortion, plus broad directional properties, *throughout* the range of 50 to 15,000 cycles).

This is the second time Dr. Olson has come to the broadcasters' aid. Way back in the days when BROADCAST NEWS was a pup, Dr. Olson developed the velocity microphone. (Those of you who kept a file will find on Page 6 of our October 1932 issue, the first published article on a velocity microphone for broadcast use). The velocity microphone was the first, and we believe is still the only type of microphone capable of uniform response to 15,000 cycles. Unfortunately, we did not, until now, have an equally good speaker.

The unit which Dr. Olson has now developed, and which is featured in the LC-1A, is called the Duo-cone—which is short for two cones on the same axis and with diaphragms at the same angle (see Page 25). Experimental models have been in use at Princeton for several years and many broadcasters have heard it there. Without exception they have been enthusiastic and have bombarded us with queries of when. Well, it's ready—come and get it!

BASEBALL TELEVISION article on Page 57 is the kind of story we would like to have more of—i.e., how it was done, what equipment was used, what the results were. Everyone is interested in how the other fellow did it. This is particularly so in television, where almost every new program establishes some new techniques. Right here and now we would like to invite the operators, engineers and directors of the present video stations to send us as much material of this kind as they can get together. We'll take it either in the form of a feature story—or as rough material which we can make into a story. Let's make the pages of BROADCAST NEWS a forum for discussion of television techniques and equipment handling. You can start by giving us your comments on this baseball writeup. Surely there's some of it you don't agree with. Write us about it—we'll publish your letter here next issue.

WELCOME TO CAMDEN. To those of you NAB Conventioneers who would like to visit our plant at Camden we extend a hearty invitation. We've made special preparations to accommodate you on Friday, September 19th (that's the day after the Convention) and will have our engineers primed to answer your questions on any equipment problem. For those of you who have no problems we have some interesting things to see; such as 300 kilowatts of FM on the air, television receivers on a mass production line, new types of test equipment, or a trip to WFIL-TV, if you'd like that better. And, we'll arrange entertainment for the wives, too.

Transportation from Atlantic City to Camden will be provided (on Friday morning) and from Camden to the Philadelphia railroad stations Friday afternoon. You can spend several hours in Camden and still catch that evening train for the west or south. See any RCA representative for details.

worth your trip to Camden

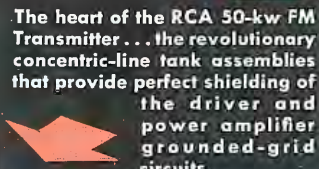

The heart of the RCA 50-kw FM Transmitter . . . the revolutionary concentric-line tank assemblies that provide perfect shielding of the driver and power amplifier grounded-grid circuits.

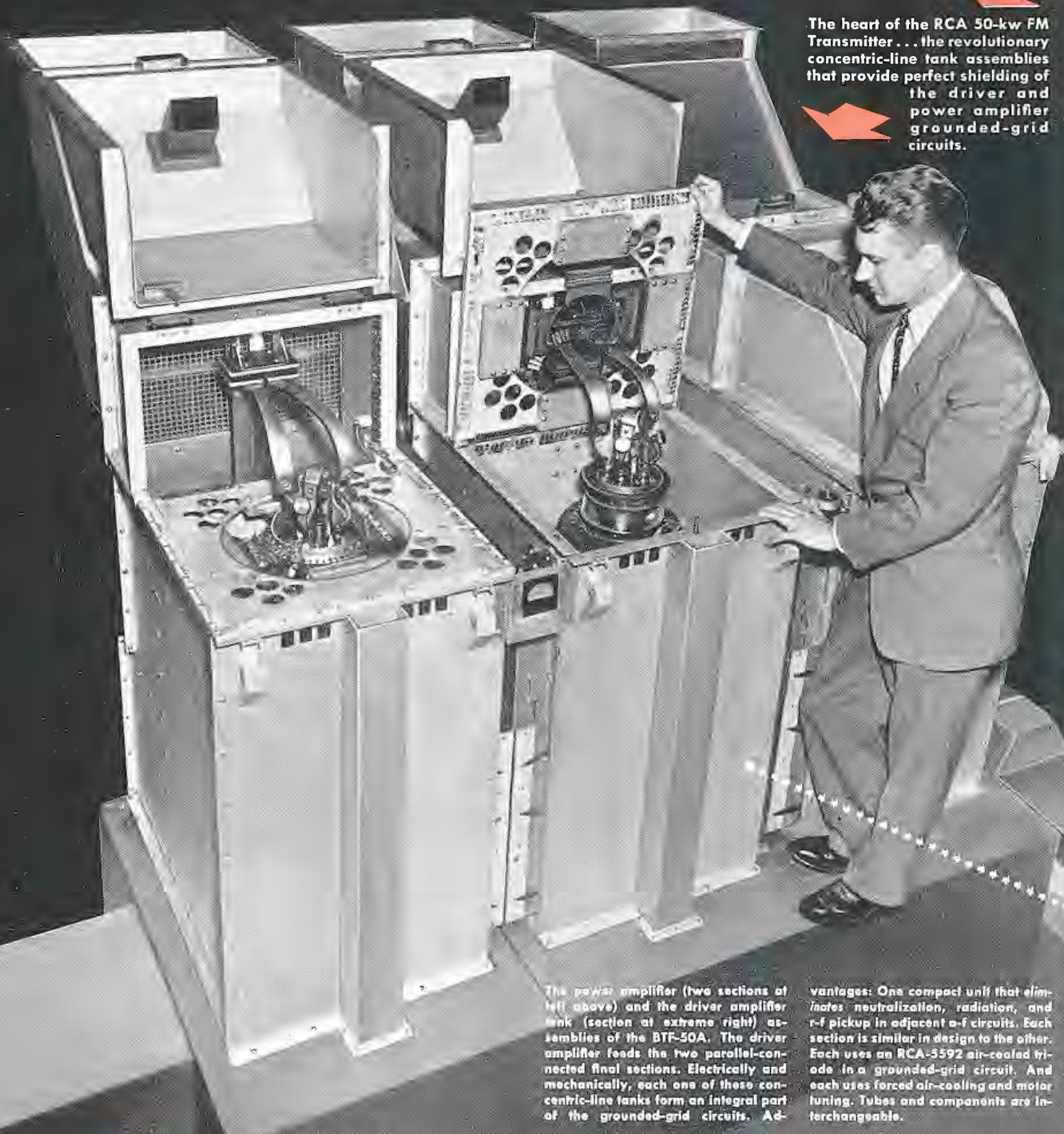

The power amplifier (two sections at left above) and the driver amplifier tank (section at extreme right) assemblies of the BTF-50A. The driver amplifier feeds the two parallel-connected final sections. Electrically and mechanically, each one of these concentric-line tanks form an integral part of the grounded-grid circuits. Ad-

vantages: One compact unit that eliminates neutralization, radiation, and r-f pickup in adjacent a-f circuits. Each section is similar in design to the other. Each uses an RCA-3592 air-cooled triode in a grounded-grid circuit. And each uses forced air-cooling and motor tuning. Tubes and components are interchangeable.



BROADCAST EQUIPMENT
RADIO CORPORATION of AMERICA
ENGINEERING PRODUCTS DEPARTMENT, CAMDEN, N.J.

In Canada: RCA VICTOR Company Limited, Montreal

To see it in action!

50 KILOWATTS OF FM POWER

The BTF-50A...now operating at full output on 108 mc

Broadcast station engineers who have watched the BTF-50A in operation put their arms around it . . . so to speak. No wonder, either. Because it handles easier than any other high-power transmitter they have ever seen . . . and it's as reliable as a powerhouse.

Here are some of its features.

Grounded-grid amplifiers and simplified single-ended r-f circuits (operating class C) insure high stability of operation and easy tuning. The Direct FM exciter produces high-fidelity frequency modulation simply and directly . . . has lower distortion than other methods . . . uses fewer tubes. Total BTF-50A tube complement, 42 tubes: 14 r-f, 2 a-f, 10 rectifier and 16 regulator and control . . . the smallest number of tubes, we believe, of any transmitter of similar rating. Of these, only 26 can seriously affect your carrier because the regulator-control tubes cannot contribute to transmitter outages. And as for spares, you need stock *only 14 different types*.

Other important design advantages include: Centralized power and control units, air-cooled tubes throughout, walk-in construction, only one high-voltage power supply . . . with spare-tube switching, and emergency cut-back with hi-lo power switching that isolates the 50-kw final amplifier for emergency 8-kw operation. Two blowers, operating independently, supply forced-air for the high- and low-power amplifiers . . . assure program continuity during emergency operation.

Here is a functionally styled 50-kw FM transmitter that will fit any type of station layout. It's compact enough to move in a standard passenger elevator . . . ideal for installing in office buildings. It's flexible. And it's economical to set up. Make sure you overlook none of its electrical and mechanical features when you inspect it in operation at Camden. Ask your RCA broadcast sales-engineer to arrange your trip, or write Dept. 19-G-2.

Production of the BTF-50A is progressing steadily to give you the earliest transmitter delivery possible.

Program fidelity that pleases audiences. Less than 1% output distortion between 30 and 15,000 cycles.

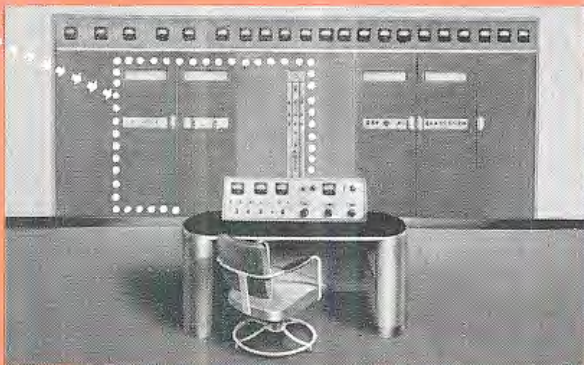
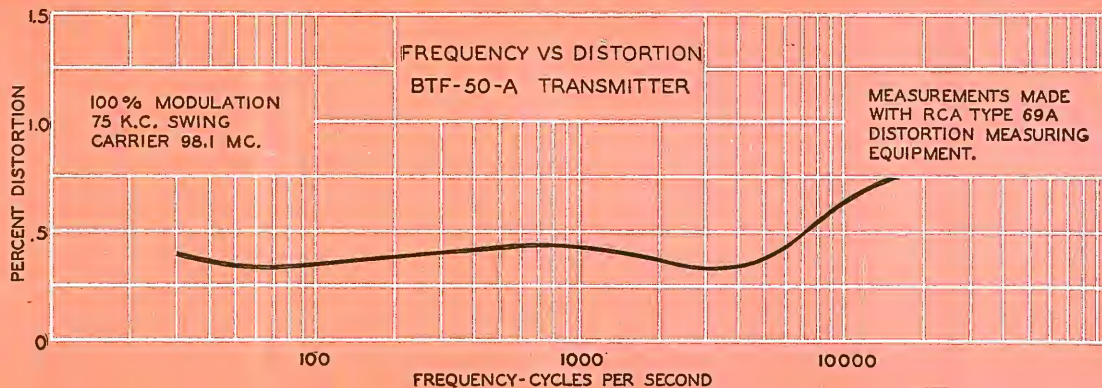

Smartly styled, the BTF-50A incorporates a unified front-panel design with centrally located control strips and flush-mounted controls. White dotted lines indicate the position (behind the front panel) of the concentric line 50-kw amplifier. Right-hand panel sections contain the 3- and 10-kw amplifiers and Direct FM exciter.

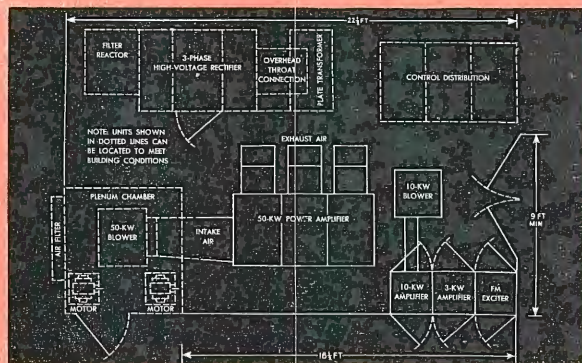

A typical floor layout for the BTF-50A. Additional equipments provided with the transmitter, but not mounted within the units are: pre-emphasis network, harmonic attenuator, transmission-line monitor, and a console which provides for audio and transmitter control. Write to nearest RCA sales office for details on various suggested floor plan arrangements.



For those of you who are visiting Atlantic City for the first time, the thrill of seeing and swimming in the Atlantic Ocean is one you'll never forget. There are, however, many exciting things to see and do in this, "the playground of America," and we hope you will find the information we have gathered for this Convention Issue of BROADCAST NEWS, both interesting and helpful.

Enjoying an early morning bike ride on the famous Boardwalk.



"The Atlantic

JUDY
Assistant

To begin with, we thought you might like to know a little about the background of this city, which has but a single industry—the entertaining of people. This is a city which entertains more visitors annually than any other resort in the world. In fact, in peak seasons they often house, feed, and entertain people totaling more than five times its normal population of 65,000.

Perhaps the most famous of Atlantic City's features its Boardwalk. The first Boardwalk was erected in the summer of 1870—when Atlantic City was little more than a seashore village whose migratory residents consisted of a handful of hardy souls who braved the tedious journey from Philadelphia (60 miles away) to indulge in a dip in the ocean. When the summer was over, Atlantic City just naturally folded up—and so did the original Boardwalk! It was a collapsible affair built in eight-foot sections which they stored away after the last visitor wended his way back home. As the city grew, the Boardwalk grew, too, until now it stretches the entire length of the island (yes, Atlantic City is an island which extends five miles out to sea and is connected with the mainland by causeways).

Almost as popular as the Boardwalk at seashore resorts is the Salt Water Taffy, which also originated in Atlantic City during its infancy. The name, derived from association rather than the ingredients, has an interesting story behind it. Local historians say that it all started when an enterprising young man decided to open a candy stand on the Boardwalk, way back in 1883. Unfortunately (or fortunately, as was evident later) an over-generous tide sprayed the small Boardwalk stand one night and doused his entire stock. The next morning, while the dis-

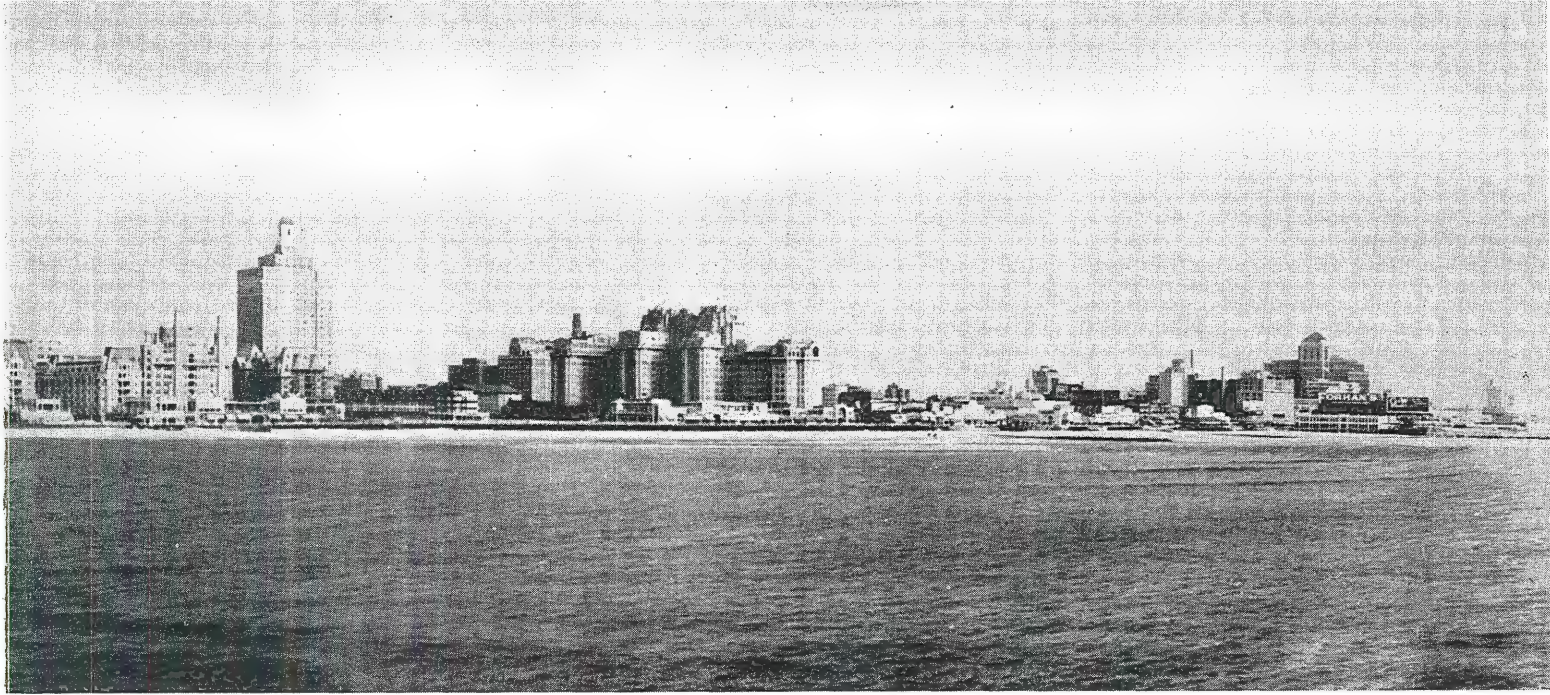

City Story"

by
J. ALESI
Editor

heartened young man sat pondering as to how to salvage his dampened wares, a little girl approached the stand. "I'll have some taffy," she said, handing him her money. "Salt-water taffy, you mean," replied the merchant, combining sarcasm with a dash of wit. Thus was born a thriving business. Millions of pounds of this taffy are sold annually.

Air view of Atlantic City's beach and Boardwalk.



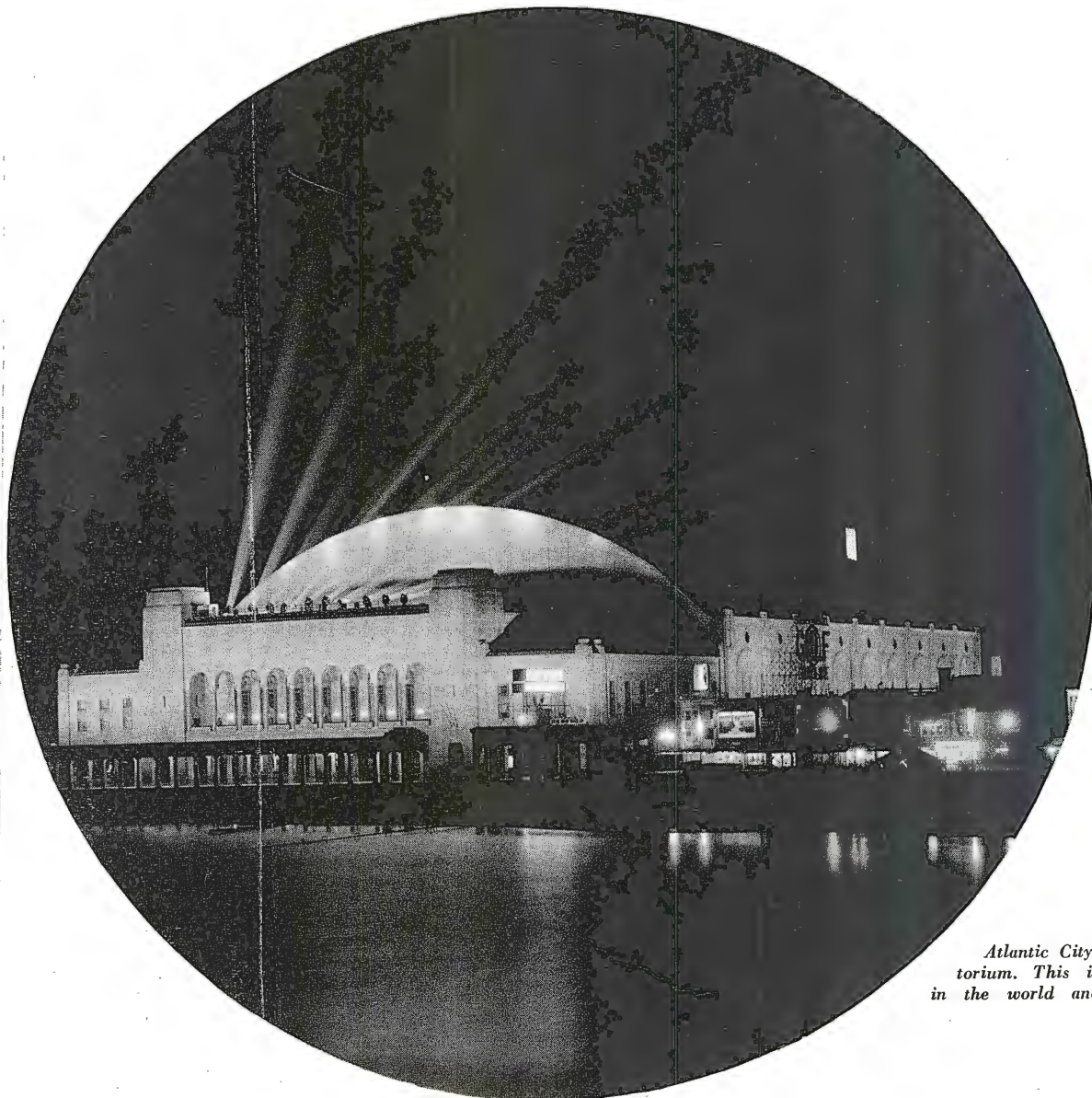

Atlantic City's Convention Hall and Auditorium. This is the largest such structure in the world and cost \$15,000,000 to build.

One of the greatest of the resort's attractions is the world-famed Auditorium and Convention Hall, where the NAB meetings are being held this year. It is the largest structure of its kind in the universe, occupying a full block on the Boardwalk and offering a main hall which is 488 feet long, 283 feet wide, and 137 feet high. It has no pillars and the roof is supported by one of the largest trusses in the world. It is large enough to play football on a regulation-size field and seat 15,000 spec-

tators at the same time. The ballroom seats 6,000 and, with more than 50 other meeting rooms, it gives the whole building a seating capacity of 70,000—greater than the population of Atlantic City itself!

Now, for a bit about the facilities in Atlantic City. As you will notice from the skyline view, the city side of the Boardwalk is lined with huge hotels, broken by blocks of shops (including some of the most exclusive jewelry and fur shops in the country),





The popular Boardwalk Rolling Chairs—the perfect way to end a perfect day.

restaurants, exhibit rooms and theaters. The Boardwalk theaters are: the Apollo, New York Avenue; the Strand, Virginia Avenue; the Stanley, Kentucky Avenue; the Virginia, Virginia Avenue; and the Warner, Arkansas Avenue.

On the ocean side are the famous piers. These include Central Pier, located at Tennessee Avenue and which features a model homes exhibit; Million Dollar Pier, at Arkansas Avenue, where you will find dancing, sun decks, and amusements; Steel Pier, at Virginia Avenue, which also offers dancing to top bands, amusements, movies, and sun decks; and the Steeplechase Pier, North Carolina Avenue, which specializes in amusements for children.

If you feel energetic, there are lots of sports in which you can indulge besides ocean bathing. There is bicycling on the Boardwalk from six to nine every morning. Or, if you prefer a morning canter, there are horses available during this same time. If golf's your favorite, there are several courses close by and your hotel will be happy to make the necessary arrangements for you. Then there's fishing, which naturally plays an important role in Atlantic City. You can go deep-sea fishing on a boat which leaves from Captain Starn's Pier (in the Inlet) every morning at 9:00, or you can hire rowboats for bay fishing.

If you're not so energetic . . . there are the rolling chairs on the Boardwalk where you can relax and enjoy the ocean breezes, and there are sightseeing tours, by land, air, and sea. For motor sightseeing you can drive through Absecon Island and Ocean City on a bus which leaves from Arkansas Avenue and the Boardwalk at frequent intervals. For our sea-faring friends there are two boat tours to choose from, one from Hackney's Restaurant and one from Captain Starn's place. Both are located in the Inlet and have tours leaving every couple of hours. There are also daily seaplane rides from Captain Starn's pier.

As you've probably gathered by this time, there's never a dull moment in Atlantic City. As a matter of fact, you'll probably be so active (even though you may not realize it) that you'll find your thoughts forever turning to food. If you can resist the Boardwalk barkers, with their hot dogs, popcorn, and frozen custards, you'll have many a memorable meal, for Atlantic City learned early in the game that the way to a man's heart is through his stomach. We couldn't possibly give you a complete list of all the fine restaurants, but the following is a list of some of the most popular ones.

* Acknowledgement is made to The Atlantic City Press Bureau and The Convention Bureau for making available photographs and information for this article.

RESTAURANTS

<i>NAME</i>	<i>LOCATION</i>	<i>WHAT YOU GET FOR YOUR \$\$</i>
HACKNEY'S	215 Main Avenue (Inlet end of Boardwalk)	World-famous sea food restaurant. Features "Purified" lobster pools. Steaks, chops, chicken and liquor served, too. Open 11 a.m. to 12 p.m.
CAPTAIN STARN'S	Inlet end of Boardwalk	"Eat where they are caught." Own fishing fleet makes daily trips to sea. Novel Yacht Bar. Noon to 10 p.m.
NEPTUNE INN.....	Pacific Avenue at Albany	Sea food, steaks, chops Game cooked on advance order. 3 p.m. to 2 a.m.
DOCK'S OYSTER HOUSE.....	2405 Atlantic Avenue	Oldest "Oyster House" features sea food of all varieties as principal menu. Noon to 10 p.m.
GREATER PITTSBURGH CAFE.....	142 South Tennessee	Noted sea food; open kitchen; own baking; bar. Closed Tuesdays.
KNIFE & FORK INN.....	Albany at Pacific Avenue	Famed unique inn featuring sea food; steaks, jumbo chops cooked to order; beverages. Open 1 to 10 p.m.
THE EDGEWATER	Amherst Avenue at 35th Street (On the bay, where Margate and Longport meet)	Delightful marine setting; good dinners and drinks; piano melodies during dinner and in the evening. Cocktail lounge open 2 to 2; restaurant, 5 to 2.
LIDO VILLAGE.....	3006 Atlantic Avenue	Italian food, wines and liquors. 4 p.m. to 9 p.m. Closed Tuesdays.
MOSCA'S VILLA MARE.....	3538 Pacific Avenue	Italian cuisine in a pleasant setting. Open 5 to 9 p.m.
DRAGON'S DEN	2021 Boardwalk	Chinese and American food; cocktail lounge.
BERT CRAMER'S	South Carolina and Pacific Avenues	"Just a bit of Sweden" Smorgasbord. Full-course dinners; steaks and chops a la carte.
FASSA MOROCCO	2801 Atlantic Avenue	Continental dinners with Swedish Smorgasbord included. Open for lunch and dinner.
SHUMSKY'S	Pacific Avenue at Georgia	Roumanian and Jewish dishes, wines and liquor.

NIGHT SPOTS

THE SHELBURNE	Boardwalk at Michigan Avenue	"The Talk of the 'Walk!" New modernistic cocktail lounge. No minimum, no cover charge.
CANDLELIGHT ROOM	The Brighton Hotel Indiana Avenue at Boardwalk	Try their famous Brighton Punch. Dining and dancing nightly.
HOLIDAY ROOM	The Mayflower Hotel Boardwalk at Tennessee Avenue	Dinner 6 to 9, a la carte until closing. Dancing and entertainment nightly. No minimum, no cover.
SUBMARINE GRILL	Traymore Hotel Boardwalk at Illinois Avenue	Music in the Patio 4 to 7; in the Grill 9 until closing. Dancing nightly.
ROUND-THE-WORLD ROOM	Hotel President Boardwalk at Albany Avenue	Dinner 6 to 9, continuous entertainment; air-conditioned. No cover, no minimum.
BABETTE'S	Pacific Avenue at Mississippi	Famous for charcoal-broiled steaks, dinner and evening shows. No cover.
CLICQUOT CLUB	15 North Illinois Avenue	Continuous entertainment and dancing; all-girl show; musical bar. Shows start at 9, 11:30, and 2:30. Food at all time; no cover.
EL CAPITAN	St. James and Boardwalk	Beautiful cocktail lounge and bar featuring mixed drinks made with fresh fruit. Continuous music from noon.
CHATEAU RENAULT	1617 Boardwalk	Music, dancing, good food and beverages.

NAB FEATURES DAY-LONG ENGINEERING CONFERENCE

Bringing to its members the most recent and important developments in broadcast engineering, the National Association of Broadcasters will present at the opening day of its Annual Convention, on September 15th at Atlantic City, a day-long Engineering Conference.

Judge Justin Miller, President of the NAB, will open the Engineering Conference with an address of welcome. The agenda, prepared under the direction of Royal V. Howard, NAB Director of Engineering, will encompass a broad field of engineering problems and developments and will feature, at the closing session, an FCC-Industry Roundtable.

The morning session, to be presided over by Orrin W. Towner, Chairman of the NAB Engineering Executive Committee, will open with a discussion on Television by O. B. Hanson, Vice-President and Chief Engineer of the National Broadcasting Company.

The second paper will be given by Paul A. de Mars, FM pioneer, who will speak on "Frequency Modulation Broadcast Station Construction." This paper will deal with the technical and economic problems that are encountered in the construction of broadcast transmitter facilities.

The final paper of the morning session will bring to the podium John D. Colvin, Audio Facilities Engineer, American Broadcasting Company, who will give an illustrated talk on "Audio Considerations for Broadcast Stations," with emphasis on improved physical and electrical operation.

Following the luncheon recess, the afternoon session, presided over by Mr. Howard, will open with a symposium on "Trans-

mitter Maintenance for Small and Medium-Sized Stations." This will be conducted by G. Porter Houston, Chief Engineer of WCBM, Baltimore, Maryland, for the Small Stations, and Alfred E. Towne, Director of Engineering of KSFO, San Francisco, for the Medium-Sized Stations. Mr. Houston will delve into the fundamentals of maintenance and Mr. Towne will discuss and illustrate the practical adaptations of maintenance procedures.

The second paper in the afternoon session will attempt to clarify one of the major problems facing engineers in modern radio allocation when Dixie B. McKey, Consulting Radio Engineer of Washington, will present his lecture on "Directional Antennas, Their Care and Maintenance."

At 3 p.m. George P. Adair, former Chief Engineer of the FCC and now a radio Engineering Consultant in Washington, will speak on the "Technical Regulation of Radio." Mr. Adair will elaborate on technical regulations, both past and future, the responsibilities of the Commission, the Broadcaster and the Engineer.

The final session of the afternoon will be the FCC-Industry Engineering Roundtable. The Commission representatives, headed by Chief Engineer George E. Sterling, will be: Dr. John A. Willoughby, Assistant Chief Engineer; James E. Barr, Chief, Standard Broadcast Division; Cyril M. Braum, Chief, FM Broadcast Division; and Curtis B. Plummer, Chief, Television Broadcast Division. This "Information Please" panel will attempt to answer all regulatory engineering problems presented by the engineers in attendance.



ROYAL V. HOWARD, B.Sc., NAB Director of Engineering has had twenty-five years of radio experience as an engineer, consultant, inventor and scientist. Before coming with NAB in May, 1947, Mr. Howard, for a period of 14 years, was Vice-President in charge of Engineering for The Associated Broadcasters, Inc., of San Francisco. During the War Mr. Howard was Director of a special Headquarters ETOUSA Scientific Staff in Europe with the Army for the Office of Scientific Research and Development. He also served as a Member of the Board of War Communications, on International Broadcasting. At present, Mr. Howard is Technical Adviser to the United States Delegation at the International (Radio) Conference.



ORRIN W. TOWNER, Chairman of the NAB Engineering Executive Committee for 1947, is Technical Director of Radio Station WHAS in Louisville, Kentucky. He was born in March, 1903, at Peterson, Iowa, received his B.S. in E.E. from the University of Kansas in 1927, and in 1933 his E.E. Mr. Towner was in charge of broadcast operation of Stations WREN and KFKU in 1927. From 1927 to 1938 he served with Bell Laboratories in its Radio Development Department. Mr. Towner was Technical Director of WHAS from 1938 to 1942. During the War he served as Associate Director of Airborne Instruments Laboratory of Columbia University, Division of War Research (1942-1945). At the close of the War he returned to WHAS as Technical Director.



G. PORTER HOUSTON is Chief Engineer, WCBM, Baltimore, Maryland, his home town, and a graduate of Baltimore Polytechnic Institute. His B.S. in E.E. was received from Johns Hopkins University. Mr. Houston's early radio experience was received when he served as a wireless operator aboard various vessels. His broadcasting career started in 1925 as Chief Engineer of WCAO. In 1930 he joined WCBM in Baltimore as Chief Engineer. From 1942 to 1946 Mr. Houston served with distinction in the Office of the Chief Signal Officer, Operational Research Staff, War Department. At the close of the War he returned to his old position as Chief Engineer of WCBM. Mr. Houston was Chairman of the NAB Engineering Executive Committee in 1946.



PAUL A. de MARS, born in January, 1895, in Lawrence, Massachusetts, received his B.Sc. from M.I.T. in 1917. He served in World War I from 1917-1920, and on his return joined with the New England Telephone and Telegraph Company, as an Engineer. He left to become Head of the Electrical Engineering Department for Tufts College in 1927. From Tufts he went with Network, Inc., Boston, as a Technical Director and was one of the outstanding and enthusiastic proponents of FM, planning and building the pioneer Paxton and Mount Washington stations. From 1942 to 1945, Mr. de Mars served in the Navy. Since then he has been associated with Raymond M. Wilmette, Inc., directing their broadcasting consulting, engineering and construction.



DIXIE B. McKEY, Radio Engineering Consultant of Washington, served with the U. S. Navy in Communications from 1914 to 1923. He entered broadcasting via the AT&T in connection with the engineering and installation of WEAJ. From 1926 to 1930 Mr. McKey worked on the design and installation of AT&T's high power overseas radio telephone equipment at Deal Beach and Lawrenceville, N. J. In 1936 he joined Graybar as District Manager, later serving as General Communications Engineer. In 1944 Mr. McKey left Graybar to be Technical Adviser of the radio properties of the Oklahoma Publishing Company, including Radio Stations WKY, KLZ, KVOR. From 1945 to date Mr. McKey has been a Consulting Radio Engineer in Washington.



GEORGE P. ADAIR, Consulting Engineer, Washington, D. C., was born in December, 1903, in Rancho, Texas. He received his B.S. in E.E. from Texas A & M in 1926. Having spent three years with the General Electric Company, Mr. Adair joined the staff of the then Federal Radio Commission, transferring to the present FCC in 1934 when it was formed. From 1936 to 1939 he was Acting, Assistant Chief of the Broadcast Division. Mr. Adair was made Assistant Chief of the Division in 1939 and Assistant Chief Engineer in 1941. In 1944 he was appointed Chief Engineer, which position he held until he resigned in 1947, to establish his own consulting practice with an office in Washington, D. C.



OSCAR B. (O.B.) HANSON, Vice-President and Chief Engineer of the National Broadcasting Company, was born in Huddersfield, England. Brought to the United States as a youngster, Mr. Hanson returned to England to study at the Royal Masonic Institute at Hertfordshire. He completed his education at Hillyer Institute, Hartford, Connecticut. He showed interest in radio, and after serving as a ship operator was made Chief Engineer of WAAM in Newark, N. J., in 1920. His outstanding work at this station brought him to WEAJ where he was Plant Engineer until the formation of NBC in 1926. Several years after NBC began its operation, Mr. Hanson was named Chief Engineer and was elevated to the Vice-Presidency in 1938.



ALFRED E. TOWNE, Director of Engineering, The Associated Broadcasters, Inc. (KSFO, KWID, KWIX, KSFO-FM—KWIS-TV), San Francisco, was born in 1906 at Bellingham, Washington. Mr. Towne received his B.S. in E.E. from California Institute of Technology in 1929. On graduation, he was employed by the General Electric Company, Schenectady, New York, in the Transmitter Test and Development Section. From 1931 to 1937 Mr. Towne was Radio Test and Design Engineer for a large manufacturing concern before coming to KSFO, San Francisco, as Transmitter Supervisor. In 1938 he was made Chief of Radio Transmission Facilities, and, in May 1947, was appointed Director of Engineering.



JOHN D. COLVIN was born in June, 1907, at Wilkes-Barre, Pennsylvania. He was graduated from the Bliss Electrical School, Washington, D. C., in 1928 and received his B.S. in E.E. from Penn State in 1934. From Penn State he started work with RCA in their Harrison plant and in 1936 was transferred to the Indianapolis plant where he worked on the design of radio tube manufacturing and test equipment. From 1938 to 1945 he worked on the design of custom built broadcast studio equipment. At the time Mr. Colvin left he was doing System Engineering for RCA on broadcast equipment. From 1945 to the present time Mr. Colvin has been in charge of Audio Facilities for the American Broadcasting Company.

FCC Engineers who will participate in FCC-Industry Roundtable

GEORGE E. STERLING, Chief Engineer, FCC, was born at Peaks' Island, Portland, Maine, in June 1894. He took special courses at Johns Hopkins University and Baltimore City College. Mr. Sterling's experience in radio dates from 1908 when he established his first amateur station. In 1913, he obtained his amateur license. Mr. Sterling served on the Mexican Border and overseas with the 103rd Infantry, 26th Division. He later transferred to the U. S. Signal Corps at Langres, France and assisted in organizing and operating the first radio intelligence section of the Signal Corps in France; for this work he received a citation from Chief Signal Officer for "especially excellent and meritorious service". Mr. Sterling served as a radio operator in the Merchant Marine. In 1922 he entered commercial employment as a marine radio inspector. Mr. Sterling entered the Federal service as a radio inspector, Department of Commerce, in 1923. He was appointed Inspector in Charge of the 3rd Radio District, Federal Radio Commission, with headquarters at Baltimore, Maryland, in 1935. Advancing rapidly, in 1942 Mr. Sterling was promoted to Assistant Chief Engineer and Chief of the Radio Intelligence Division, and, in 1945, was appointed Assistant Chief Engineer in charge of Field and Research Branch. Mr. Sterling is the author of the well-known "The Radio Manual". He served as a Delegate to the Air Navigation Aids Conference at London, England, in 1945, and subsequently at Indianapolis, Indiana, in 1946.



GEORGE E. STERLING, Chief Engineer, FCC.

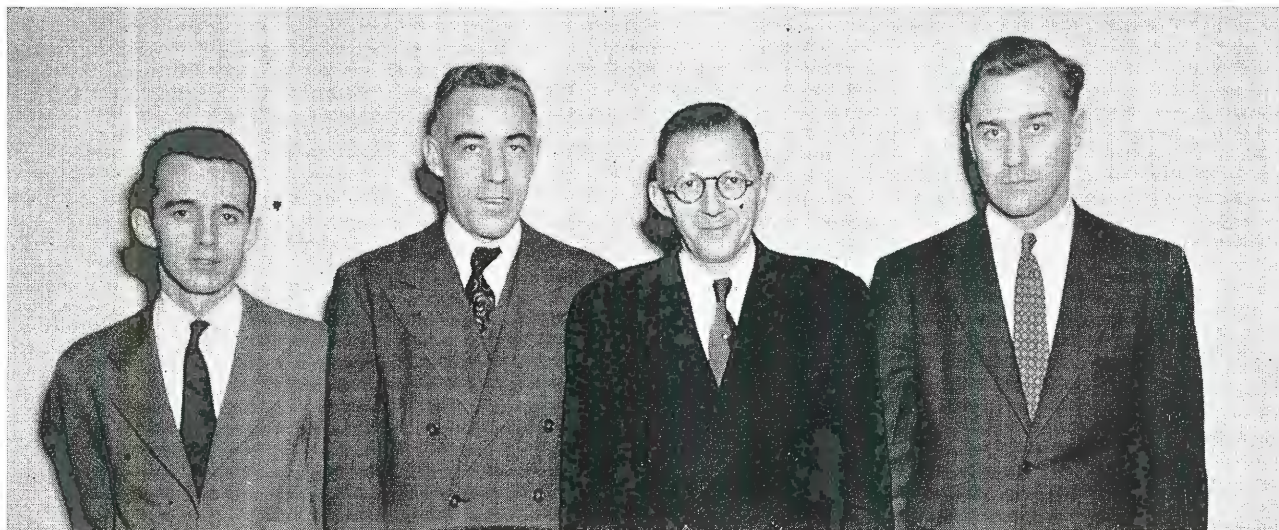

COMMISSION ENGINEERS who will participate in roundtable include (left to right) Curtis B. Plummer, Chief, Television Broadcast; James E. Barr, Chief, Standard Broadcast; John A. Willoughby, Asst. Chief Engineer; Cyril M. Braum, Chief, FM Broadcast.

JOHN A. WILLOUGHBY, Assistant Chief Engineer in charge of Broadcast, FCC, was born in Florence, South Carolina, in July, 1893. He attended Clemson College, George Washington University and Harvard University, specializing in electrical engineering and communications engineering. During his early days in radio work, Mr. Willoughby invented the submarine loop antenna which was installed on all of our submarines during the latter part of World War I. Later he developed the interlocking "A" and "N" system which was the predecessor of the present high frequency system employed by both government air-ways and commercial lines. Mr. Willoughby entered the services of the Commission in August, 1930. Since October, 1944 he has been Assistant Chief Engineer in charge of Broadcast.

JAMES E. BARR, Chief of the Standard Broadcast Division, FCC, was born in Texas in December, 1907. After graduating from high school in 1926, he studied two years at Georgia School of Technology, Atlanta, Georgia, and

two years at Southern Methodist University, Dallas, Texas. From 1929 to 1932 Mr. Barr was employed by Southwestern Bell Telephone Company on outside plant construction. He was with Southwest Broadcast Company, Fort Worth, Texas, Stations KTAT, KOMA, KTSA, WACO, and KNOW from 1933 to 1938. From 1938 to 1940 Mr. Barr was Radio Inspector with the FCC with headquarters in New York City. Mr. Barr has been with the Standard Broadcasting Division, Engineering Department, FCC from 1940 to date.

CYRIL M. BRAUM, Chief, FM Broadcast Division, FCC, was born in Sacred Heart, Minnesota, in March, 1907. He attended the University of Minnesota, where he received his B.S. in E.E. Mr. Braum was Chief Engineer for Radio Station WDGY in Minneapolis from January 1929 to December 1929. From January to September, 1930, he was with Electrical Research Products, Inc., in New York City. Mr. Braum was Radio Operator with the Minneapolis

Police Department from December 1930 to October 1937. From 1937 to 1940 he was Radio Inspector with the FCC in Chicago; from 1940 to date he has been Chief of the Non-Standard Broadcast Applications Section, now FM Broadcast Division of the FCC, in Washington, D. C.

CURTIS B. PLUMMER, Chief, Television Broadcast Division, FCC, was born in Alfred, Maine, in 1912. He received his B.Sc. from the University of Maine in 1935. Having helped work his way through school working in radio, Mr. Plummer entered the professional field as a field installation engineer for the Radio Receptor Company in New York City. In 1938 he entered broadcasting via WGAN, Portland, Maine, and left in 1940 to become a Radio Inspector with the FCC. Mr. Plummer joined the Broadcast Division of the FCC in Washington in 1941, and during the War he worked on International Short Wave and other broadcast services. He became Chief of the Television Broadcast Division in 1945.

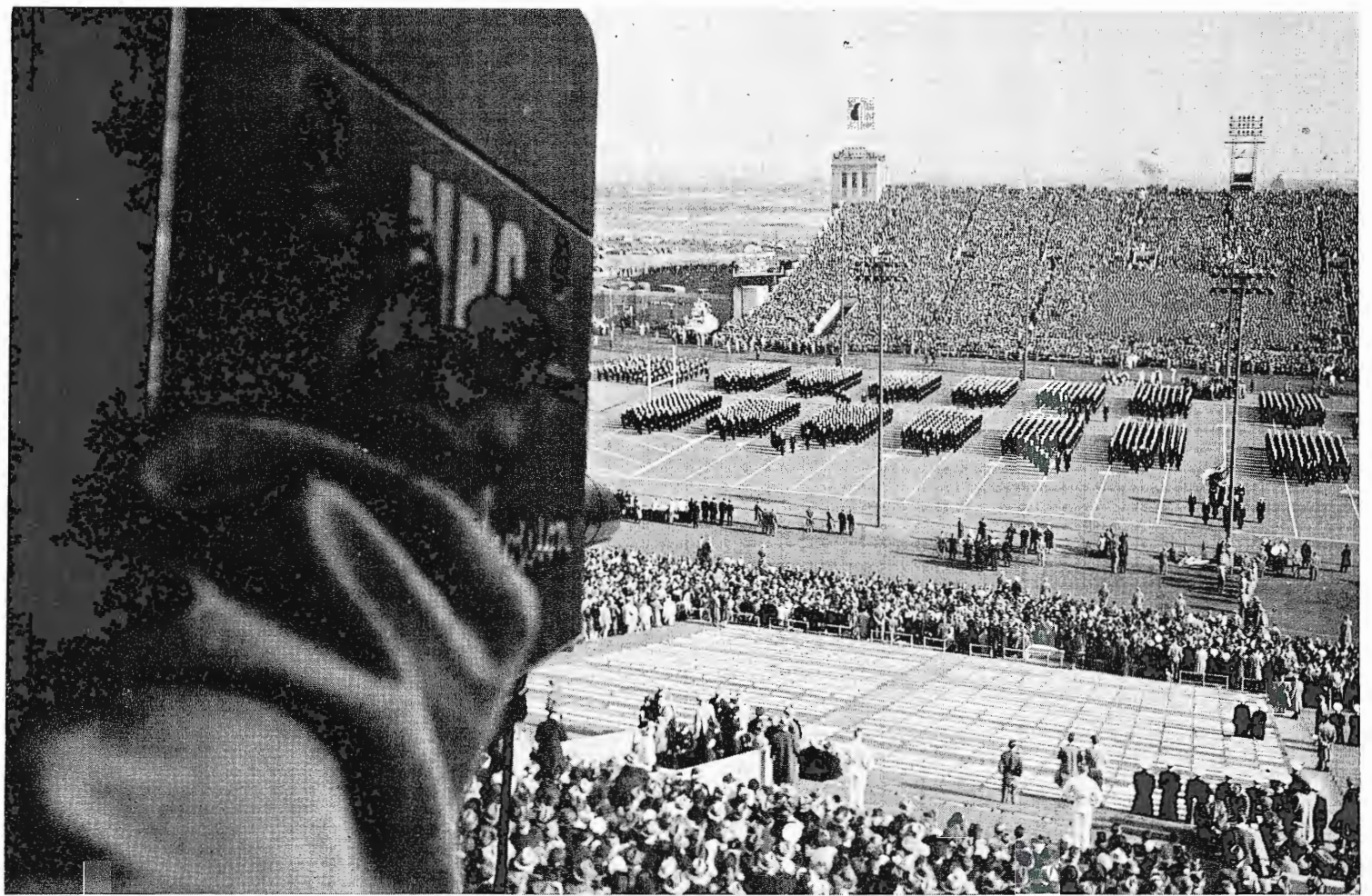

FIG. 1. NBC used three cameras for the Army-Navy Football Game from Municipal Stadium, Philadelphia (December 1946). One shown here was located as high as possible, near the center of the field.

HOW NBC USES THE RCA

by

F. A. WANKEL and E. C. WILBUR

National Broadcasting Company

MEET THE AUTHORS



F. A. WANKEL
Eastern Division Engineer
NBC, New York



E. C. WILBUR
Television Field Supervisor
NBC, New York

When NBC made first use of the RCA-Type TK-30A Field Cameras with the Image Orthicon for the pickup of the Louis-Conn fight in the Yankee Stadium in June, 1946, all previously-used field pickup equipment was made obsolete. The television picture produced was so superior to the previously-employed standard orthicon camera, that it would have been inconsistent with the rendering of a public service to again revert to its use. Since the evening of this fight, NBC has used the Image Orthicon exclusively for all of its television-field programs and a summary of the operations for 1946 appears in Table No. 1. The original set of equipment in New York, consisting of two RCA TK-30A Cameras and associated auxiliaries, has since been augmented by a second set of two cameras with a third set on order. Two complete sets of audio equipment are available for the accompanying sound. Each set includes an RCA OP-7 combination, plus standard microphones, parabolic microphones, and monitoring loudspeakers.

The two original NBC Telemobile Units, which first transported the Iconoscope Cameras, and then the Orthicon Cameras, have again been revised to utilize the Image Orthicon equipment. The equipment has been mounted to permit operation within the vehicles or to remove it if the program requires.



FIG. 2. The other two cameras were located lower down and closer to the field, as shown here. On the field, in this picture, are the Army Cadets. View on the opposite page shows the Navy Midshipmen.

IMAGE ORTHICON CAMERA

FIG. 3. The two telemobile units parked outside the stadium. Note cables running from unit at left up over stadium wall. The unit at right was used for transportation only.

Whenever possible, all of the equipment except the cameras is operated within the vehicles, since this reduces the equipment setup time, and is an operating convenience.

In order to distinguish between the two sets of pickup equipment, every item of each set is marked with a distinctive color. This includes all "suitcase" equipment and accessories; such as cables, tripods, tools, microphones, etc. This color coding assures the taking of the proper units to a pickup and aids in reference to the "Blue" or "Green" equipment during discussion or scheduling. A complete set of spare tubes, a few spare parts, tools, etc., accompany each set of equipment and are transported in color-coded fibre carrying cases as follows:

- 1 case with one 50-foot camera cable and one 25-foot power cable.
- 1 case with one 50-foot camera cable and one 100-foot power cable.
- 1 case with equipment, interconnecting cables, and adapters.
- 1 case with audio cables and adapters.
- 1 case with spare tubes and circuit schematic diagrams.
- 1 case with video spare parts, tools, and telephone sets for communication.
- 1 case with audio spare parts, tools, and microphones.



TABLE NO. 1
IMAGE ORTHICON PICKUPS — June 1946 to December 1946

Location	No. of Programs	Air Time		Facilities
		Hrs.	Min.	
Madison Square Garden.....	16	28	55	*Line
Polo Grounds	21	63	26	Microwave
St. Nicholas Arena	22	37	17	*Line
Yankee Stadium	14	37	27	*Line
Freeport Stadium, Long Island.....	1	2	35	Microwave
West Side Tennis Club.....	9	44	52	Microwave
Jackson Heights Tennis Club.....	1	6	31	Microwave
Pennsylvania Post Office.....	1		25	Microwave
Downtown Athletic Club.....	1		33	Microwave
Studio 8G—Radio City.....	2		57	Local Coaxial
Gimbels, New York City.....	1		19	Microwave
Rockefeller Plaza	1		10	Local Coaxial
Times Building	1		17	Microwave
Astor Hotel	1		41	Microwave
Times Square	1		32	Microwave
Waldorf Astoria	5	10	46	Microwave
Baltimore, Maryland	1	3	04	Microwave and Coaxial
United Nations, Flushing.....	3	10	17	Microwave
Roxy Theater	1		53	Microwave
Astor Theater	1		20	Microwave
Municipal Stadium—Philadelphia, Pa.....	1	3	46	Microwave and Coaxial
West Point, New York.....	3	8	23	Telephone Co. Radio Relay
21 Club	1		18	288 Mc Relay
Ebbets Field	14	40	27	Microwave
Philco Pickup—NBC Microwave Relay, Phila., Pa.	3	8	28	Coaxial
TOTAL.....	126	311 Hrs.	39 Min.	

* "Line" indicates balanced telephone pairs as distinguished from coaxial cable.

1 case with camera equipment, including viewfinder, telephone sets for cameras, tools and spare parts.

1 case with camera auxiliaries, including lenses, panning handles, fittings for various types of tripods, spare tubes, and mounting bolts for "high hats". (A panning arrangement which is secured to a table or bench).

Larger quantities of power cable, camera cable, microphone cable, etc. are carried on reels in the vehicles.

A set of RCA Microwave Television Relay Equipment is used for relaying the television program from the remote point to Radio City. Facilities are available on the roof of the RCA Building for the installation of the necessary receiving parabola and wave guide which constitute the receiving antenna. The output of this antenna is fed to the relay receiver on the floor below, where suitable video monitors and cathode-ray oscilloscopes are mounted permanently for monitoring. The receiver output is suitably fed to a coaxial cable which transmits the signal to the fifth floor television master control room. From this point on, the circuit continuity is identical to that of a live studio or film transmission originating in Radio City, since the signal is transmitted via the identical line amplifiers and coaxial cable to the WNBT Transmitter in the Empire State Building.

The relay receiver was installed in the Empire State Transmitter Room in a few instances where line-of-sight transmission was not possible on the RCA Building. In these cases, the signal was fed directly to the WNBT Transmitter, and the Master Control Room was by-passed. Television programs that originate in standard broadcast studios, or in the vicinity of Rockefeller Plaza, are transmitted to the master control room by means of

permanently-installed coaxial cable. Programs originating at Madison Square Garden, St. Nicholas Arena, and the Yankee Stadium utilize balanced telephone company circuits for transmission to the master control room. The choice between telephone line and radio relay transmission is largely determined by the frequency that the location is utilized, the economy of manpower, and the nature of radio transmission path. Of the twenty-five locations listed in Table No. 1, only three used local telephone line facilities.

NBC has used the microwave relay equipment under many operating conditions, and the results have always been satisfactory. The comparatively small size and compactness of the transmitting antenna has frequently permitted its use indoors within a steel building, provided a suitably located window was available.

The pressure of operating schedules has necessitated the ordering of a second set of RCA Relay Equipment, but until it is delivered, the old relay transmitter, operating on 288 mc, is utilized—FM and amateur harmonics permitting!

The Television Field Staff of NBC in New York is not located at Radio City. A building has been leased in Long Island City, since July 1941, which is but ten minutes from Radio City by subway, and is located near the approach to the 59th Street Bridge. This provides convenient access to Manhattan and other sections of Metropolitan New York where television-field programs are originated.

TECHNICAL PERSONNEL

The normal NBC Operating Staff for television-field programs consists of the following technical personnel for a two-camera pickup which does not use a television radio relay link:



FIG. 4. The microwave antenna atop the telemobile unit parked beside Madison Square Garden. The antenna is directed toward the top of the RCA Building shown in the center of the photo.



FIG. 5. Atop the grandstand at Ebbets Field, Brooklyn, the RCA Microwave transmitting parabola antenna lined up for a direct relay to the RCA Building.

An Assistant Field Supervisor. He is in charge of the technical staff during the test and broadcast of any specific program and is not assigned any operating duties.

A Video-switching Engineer. He switches the cameras as directed by the program director, directs cameramen as required, and observes the technical picture quality on the Master Monitor Unit.

A Video-control Engineer. He adjusts all the controls for two cameras on the camera-control units. He varies contrast and brightness as necessary. He coordinates technical requirements with the Master Control Room at Radio City.

An Audio-control Engineer. He operates the audio-field amplifier, and is responsible for all microphone installations.

Two Camera Technicians. They operate the television cameras as directed, and handle emergency maintenance if necessary.

Two Technicians. They drive the telemobile units and assist in setting up the equipment, particularly doing the heavy work and cable installations.

This totals an eight-man technical crew for two-camera operation. If a television radio relay is used, an additional man is required at both the transmitter and receiver, increasing the staff to ten.

If certain types of programs extend beyond an hour, a relief camera technician may be necessary. Their work is continuously active, and on events such as baseball, football, etc., they can be expected to tire in this period of time. After about two hours, the video-control engineer may also require relief. Additional technicians may be required on an extensive installation.

SURVEYS

Whenever a new point of pickup is considered for a television program, a preliminary survey of the location is made and the answers to the following questions are specifically checked. A representative of the program department usually accompanies the engineer to give advice on the program content:

- (1) What are the specific camera and microphone locations? Is any special construction required for camera platforms?
- (2) What is the routing of power, camera, and microphone cables? Will holes be required in walls or floors?
- (3) Will operation be possible from the vehicle, or must the equipment be moved indoors?
 - (a) If operation is to be made from the vehicle, what is the parking problem? Will the cables cross the sidewalk or the street? How will the cable entrance be made to the building?
 - (b) If operation is to be indoors, what space can be used for the control room? What is the problem of loading and unloading the vehicle?
- (4) Is the proper power supply available? Is a special power installation required? Is special metering of power required?
- (5) Are unions involved—(a) for power? (b) for lighting? (c) for moving or setting up equipment?
- (6) Shall the program be transmitted to Radio City by line or r-f facilities? What is the distance and the r-f path? Are there any interfering structures or hills? Where will the transmitter and the antenna be located? How long is the coaxial cable and what is its route from the video output

(Continued on Page 18)

**"We take you
now to
Baltimore"**

**A picture story of
NBC's setup for tele-
casting the Navy-Duke
football game from
Baltimore Municipal
Stadium, October, 1946**



1. Overall view of the installation at Baltimore Stadium. The tele-mobile unit's old antenna mast served as a support for the camera, power, and microphone cables. The two cameras may be seen to the right of the lighting tower. The microwave transmitter and parabola is on a platform to the right of the top of the steps.

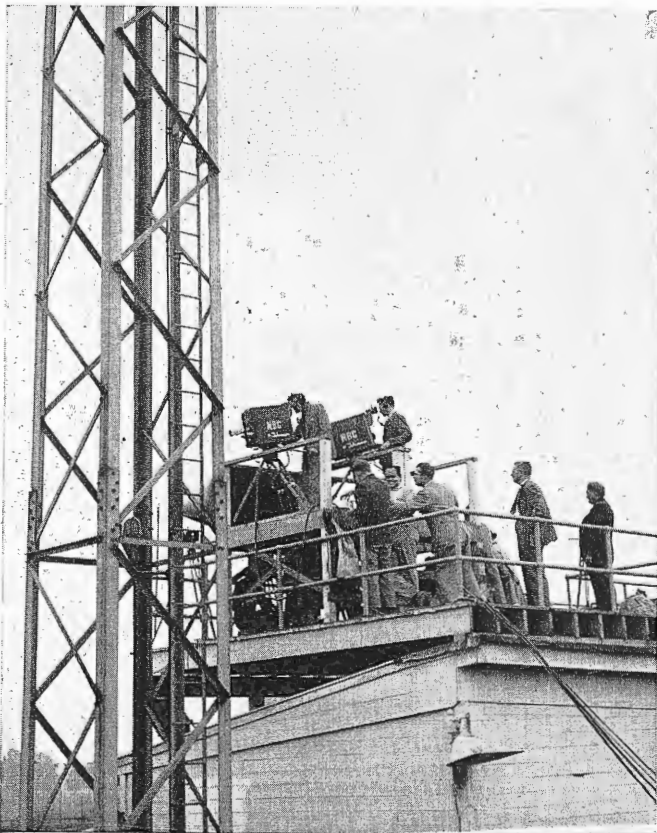

2. Cameras were mounted on a special platform at the top of the grandstand. Standard tripods, which are particularly convenient for panning and tilting, were used.

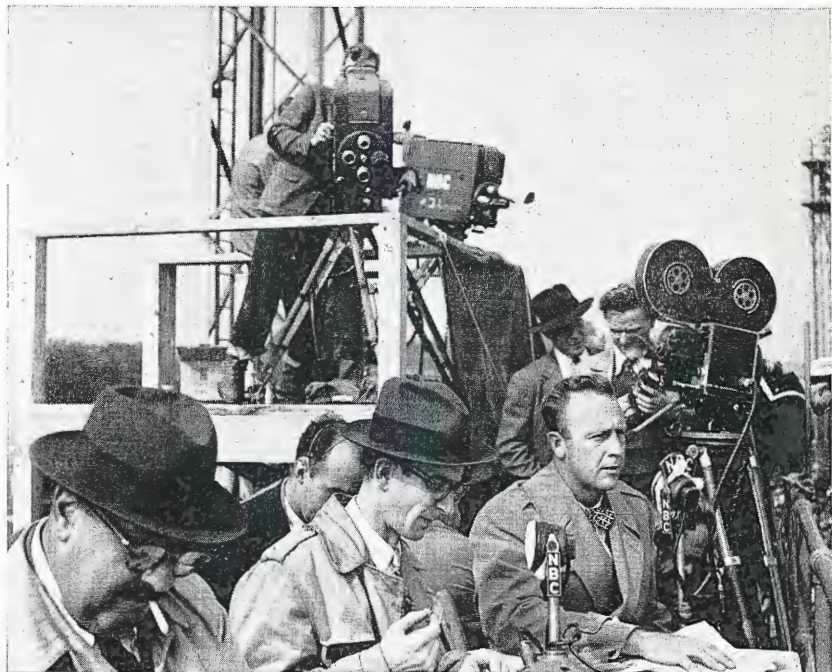

3. Another view of the camera platform, indicating the proximity of newsreel cameras. Announcer, spotters, and production are in the foreground. The RCA 50-A Microphones were covered with cloth to reduce wind noise.



4. Cables from the cameras lead to the camera control units in the telemobile, interior of which is shown in this view.



6. Video signal from the microwave transmitter was picked up by this RCA Microwave receiver located in the Lexington Building in downtown Baltimore. The output of this receiver fed the A. T. & T. coaxial cable to New York and Washington.



5. From the control position video signals were fed to the microwave transmitting equipment which was mounted on a specially-built platform, as shown here. This photo was made prior to the r-f test, during the equipment setup.

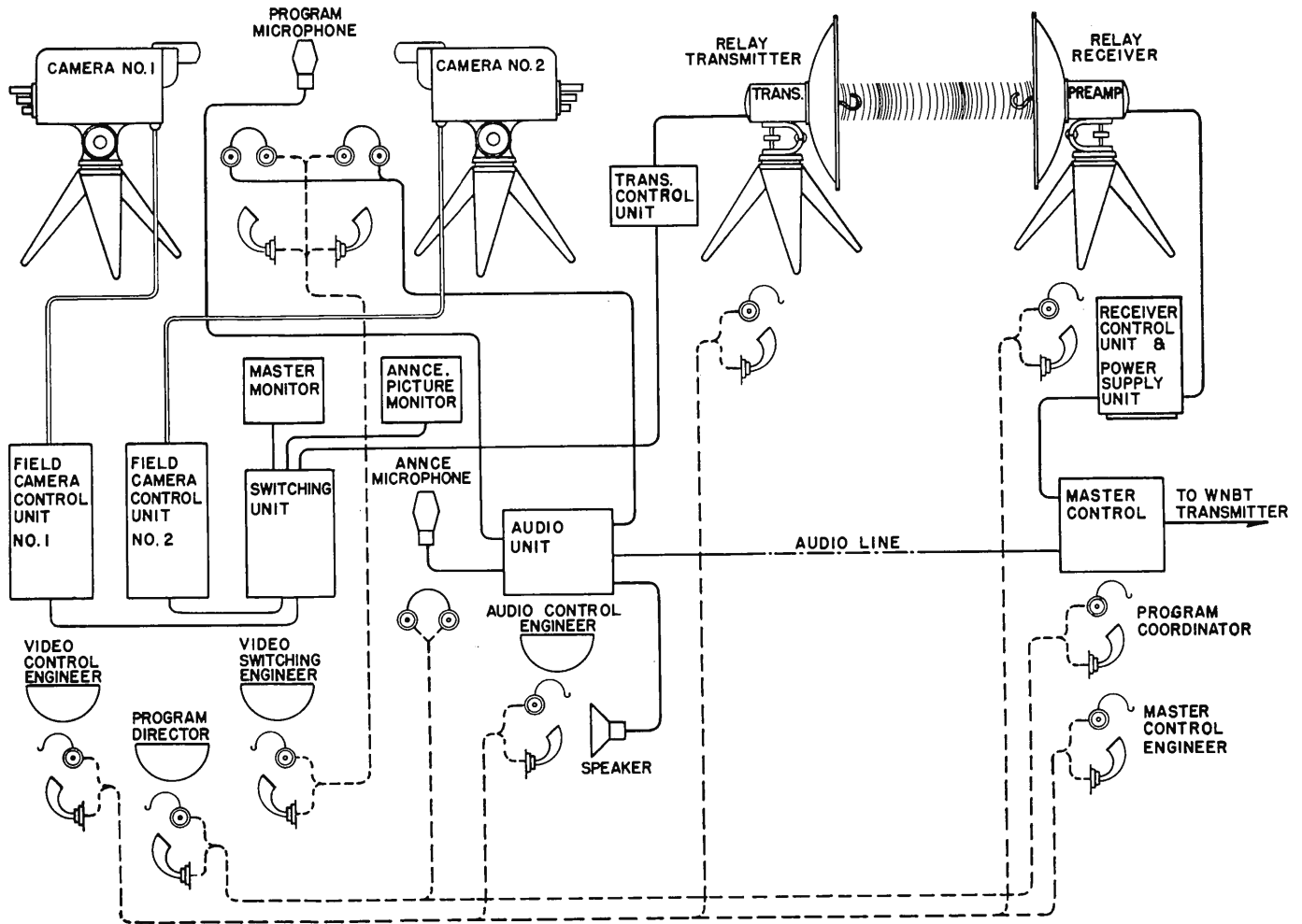

FIG. 6. Block diagram of communications facilities for typical two-camera pickup.

to the transmitter? If a radio relay is not feasible (distance or interfering structures) is a video line installation possible from an economic viewpoint? If so, is there sufficient time for its installation?

- (7) Is lighting required? Who supplies and operates it?
- (8) Where will the audio lines terminate?
- (9) Are all operating locations easily accessible and is sufficient space provided for the equipment, personnel, and emergency maintenance?

After this preliminary survey has been completed and it has indicated the practicability of the broadcast, an actual r-f test is made to determine signal acceptability. If telephone lines are required, an order is placed for these facilities. A final survey is then made and all necessary construction started. When transmission facilities and construction work is completed, an overall test, with at least one camera, is made from the pickup to Radio City. If the program is from an indoor location, changes may be required in either the intensity or the direction of the lighting. If these changes are practicable, they are made at this time. All of the data obtained on the survey is kept on file for future reference.

In some cases, it is possible to install camera and microphone cables the day before the broadcast. This may effect economy of operation by the reduction of personnel overtime costs, especially when the technical facilities are scattered over an appreciable area.

THE DAY OF THE PROGRAM

As soon as the telemobile unit and the technical staff arrive at the point of origin of the program, they setup the equipment. When this task is completed, an overall check of the entire system is made from each camera to Radio City Headquarters. Any necessary adjustments are made and operating levels are established. A final check of the equipment is made one hour before the scheduled transmission time. From then, until the actual broadcast, the field personnel continuously transmit program material to Radio City for observation and comment.

During this hour, the assistant field supervisor and the program director discuss the scenes to be picked up and the lenses to be utilized. These scenes are then checked and any necessary correction of lenses is made.

All NBC technical equipment is operated by the engineering staff. The program director gives directions for switching cameras, changing lenses (positioning of the lens turret), pickup of various scenes, and fading of microphones during the broadcast.

The camera technicians receive their instructions by telephone from the video-switching engineer, and on a separate single headphone, they may listen to the audio portion of the broadcast. This permits them to assist in coordinating the program and often to anticipate camera "shots".

(Continued on Page 20)

FIG. 7. Standard TK-30A Cameras have also been used for studio pickups with good success. This view shows them in use in Studio 8G at Radio City.



FIG. 8. Another view in Studio 8G showing the platform (at the rear of the audience) on which the cameras were mounted. Note fibre carrying cases containing camera lenses and accessories.

FIG. 9. Televising the New Year's celebration in Times Square from the Marquee of the Hotel Astor. Although the streets appear dark in the photo, the Image Orthicon successfully picked up the crowds.



ORRIN E. DUNLAP, Jr. ELECTED VICE-PRESIDENT IN CHARGE OF ADVERTISING AND PUBLICITY

Election of Orrin E. Dunlap, Jr., as Vice President in Charge of Advertising and Publicity of the Radio Corporation of America, was announced recently by Brigadier General David Sarnoff, President and Chairman of the Board of Directors.

Mr. Dunlap became Director of Advertising and Publicity of RCA on January 1, 1944, after serving for four years as Manager of the Department of Information.

Before joining RCA in 1940, Mr. Dunlap was Radio Editor of The New York Times for eighteen years. His association with radio dates to 1912, when he built an amateur wireless station at Niagara Falls, N. Y. He was among the first to become a member of the American Radio Relay League and is a life member of the Veteran Wireless Operators Association and a senior member of the I. R. E.

Mr. Dunlap, who was chief operator of the Marconi Wireless Telegraph Company of America aboard the S.S. Octorora in 1917, served during World War I as a



ORRIN E. DUNLAP, JR.

radio operator in the U. S. Navy, graduating from the U. S. Naval Radio School

at Harvard as one of the three honor men of the class. He was assigned to duty at the Naval radio station NBD, Otter Cliffs.

After graduation from Colgate University in 1920, Mr. Dunlap attended Harvard Graduate School of Business, specializing in advertising and marketing. He then joined the staff of the Hanff-Metzger Advertising Agency. A year later, he was invited by Carr V. VanAnda, Managing Editor of The New York Times, to organize a radio section and direct the coverage of radio news.

Mr. Dunlap is the author of ten books on radio, including two on advertising, "Advertising by Radio" and "Radio in Advertising." His other volumes are: "Dunlap's Radio Manual", "The Story of Radio", "Talking on the Radio", "The Outlook for Television", "Marconi: His Life and His Wireless", "The Future of Television" (1942 and 1947 editions), "Radio's 100 Men of Science", and "Radar: What Radar Is and How It Works."

(Continued from Page 18)

The video-control engineer, the audio-control engineer, and the engineer assigned to the microwave relay transmitter are connected by telephone circuits with the Radio City master control room and the relay receiver site (Figure 6). This arrangement permits the complete coordination of technical operations and the localizing of irregularities. The field program director maintains telephone contact with the pickup announcer and with another program director in Radio City. An "on-the-air" monitor is available at Radio City so that apology announcements can be made from the pickup in the event of picture or sound irregularities. This is quite important at the present stage of the industry, since the public is not educated to distinguish between transmitter and home receiver troubles. Loss of synchronizing pulses on the air, for instance, will usually result in frantic "knob twisting" in the home and subsequent telephone calls to the television service man. A simple audio announcement can properly identify the trouble, and prevent confusion and useless service calls.

A monitoring loudspeaker is supplied in the control room for the use of the audio engineer and the convenience of all other personnel at that location. A video monitor for the use of the announcer is an important adjunct since it tends to prevent his describing action on which the camera may not be focussed.

STUDIO PROGRAMS

The Image Orthicon Cameras were used twice during 1946 for studio programs originating in Radio City. Several additional studio programs were transmitted during the early months of 1947. These programs were commercial and were acceptable to the sponsors.

NBC intends to equip a new Radio City studio with Image Orthicon Cameras during this year based upon the results of

these transmissions. The level of illumination was only one-fifth of that required in the standard "iconoscope-equipped" studio, and even with this lower light level, a much greater depth of field was obtained. The use of turret lenses tremendously increased the utility of each camera, and the characteristic of the Image Orthicon increased the picture detail in the shadows.

Persons on the NBC Technical Staff who were not aware of the contemplated use of this equipment at Radio City, viewed these transmissions in their homes and were astonished the next day to learn that the Image Orthicon Cameras were substituted.

SAFETY

Safety cannot be too greatly emphasized in television operation. In addition to the usual electrical hazards, there are many unique to broadcasters. Cables larger in size than those used for microphones increase the possibility of persons tripping over them. Camera lenses may be dropped from high places if removed from their mountings. Temporary power installations require the exercise of caution to prevent the overloading of circuits with consequent fire hazard. NBC has insisted that all television field personnel be qualified in resuscitation and first aid, and reviews of their qualifications are conducted every six months. All equipment and cable must be installed securely and in a safe manner. Retaining chains are installed between camera lenses and mounts. All equipment is connected to a good electrical ground before power is applied. Carbon dioxide fire extinguishers are mounted in all mobile units and must be installed at all pickup locations, even if they are temporary in nature.

There have been no serious accidents to the public or to any NBC personnel because of an NBC television installation. This is a record we are proud of and intend to maintain indefinitely.

WARNER BROS. AND RCA PLAN JOINT PROGRAM ON LARGE SCREEN TELEVISION

Heralding an advance of far-reaching significance in the mass entertainment field, the RCA Victor Division of the Radio Corporation of America and Warner Bros. Pictures, Inc., recently announced the signing of a contract for a joint program of research on large-screen television.

Harry M. Warner, President of Warner Bros.; Jack L. Warner, Vice President in charge of production; and Frank M. Folsom, Executive Vice President of RCA in charge of the RCA Victor Division, made the joint announcement, calling the cooperative arrangement an historic step toward the development of large-screen television in the motion picture industry. The research and experimental program, it is predicted, will be as important as the first tentative efforts to put sound on film more than twenty years ago.

New types of black-and-white large-screen television equipment have been developed by the RCA Engineering Products Department in its Camden, N. J. plant, and the first elements of this television equipment will be shipped immediately to the Burbank Studio. Other components will be supplied later. In addition, RCA will provide technical and research information and the assistance of engineering personnel and field engineers.

Jack L. Warner has assigned Colonel Nathan Levinson, head of the Studios' Engineering and Technical Research Staff, to direct the experimental program for Warner's. As a pioneer in talking pictures, Colonel Levinson has made many important contributions to the development of the medium.

Commenting on the joint program, Mr. Folsom drew a parallel between Warner Brothers' foresight in undertaking this

pioneering work and its early achievements with sound film.

"Last year," the RCA executive declared, "Warner's celebrated the twentieth anniversary of the birth of sound pictures. I am confident that in 1967 this company will be observing the twentieth anniversary of large-screen television in the motion picture industry."

RCA first demonstrated large-screen television at the New Yorker Theatre early in 1941. At that time scenes televised from

Madison Square Garden, Ebbett's Field, and Camp Upton were projected on a 15 x 20 foot theatre screen.

Intensive laboratory research and development carried on since then by RCA scientists, working on applications of large-screen television for military purposes, has contributed to vast improvements in tubes, electronic circuits, and components, resulting in pictures of excellent quality by comparison with any previously demonstrated.

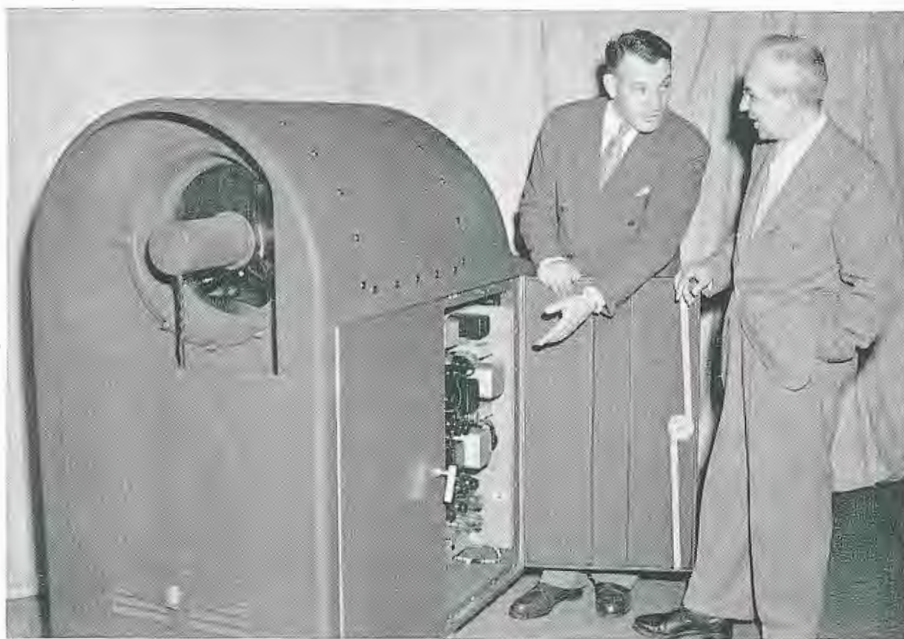

(Right, above): *W. W. Watts, Vice President in charge of the RCA Engineering Products Department, showing the large-screen projector unit to Col. Nathan Levinson (right), head of Warner Brothers Studios' Engineering and Technical Research staff.*



(Right, below): *The great magnifying power of the spherical mirror used in the large-screen television projection system is illustrated by the reflected image of the clasped hands of Col. Nathan Levinson (right), and W. W. Watts. The 42-inch mirror, ground to the precision of the finest telescope lens, weighs 350 pounds and is the largest of this type in the country.*



FIG. 1. Front view of main studio (note polycylindrical surfaces on wall and ceiling).

by

FRANK M. DEVANEY

Assistant General Manager

The new WMIN studios, located on the fifth floor of the Hamm Building in downtown St. Paul, are really the "news of the hour." Architecturally, they have been acclaimed by many as the most beautiful around, from the point of view of a small station. Technically, these studios, which have been constructed especially for FM broadcasting, represent, according to prominent engineers, the finest equipment in the United States.

The entire studio layout occupies 6,000 square feet and includes five spacious studios, audition and control rooms, and executive offices. The main studio, which is 26 by 46 feet, is of the suspended or "room-within-a-room" type, being separated from the rest of the building by several thicknesses of rubber and felt. It also features walls and ceilings of the polycylindrical design to facilitate even distribution of sound.

All the studios have year-round air-conditioning, as well as an electro-static precipitator which filters out smoke, dust and

"The News of the

pollen from the air. Lighting is indirect and fixtures are concealed in "islands" on the ceilings, as are the ventilation ducts and loud speakers.

The studios were designed under the supervision of G. R. Jacobs of New York, who reports that 5½ miles of wire were laid to complete all circuits terminating in the Master Control Room. The Master Control Room is RCA-equipped throughout—microphones, speech equipment, turntables, jack panels, amplifiers, etc. This room, incidentally, has vision into all five studios. It is possible to conduct at least four different program operations simultaneously; i.e., program on the air, audition monitoring, a program being fed in, and perhaps conducting a rehearsal.

WMIN expects to be on the air with FM broadcasts sometime this fall. To that end, the station is erecting a 445-foot tower and new transmitter building midway between the Twin Cities. With the installation of this new transmitting equipment, WMIN will be in a position to broadcast AM, FM, and television programs to carry on the tradition of fine broadcasting which they have held for eleven years.



FIG. 2. Warren B. Fritze (left) Chief Engineer of WMIN, and Hubert Humphrey, Mayor of Minneapolis, at the equipment racks in the Master Control Room.

FIG. 3. *Edward Hoffman, owner of WMIN, points out the montage in the beautiful WMIN reception room to Minnesota's Governor, Luther Youngdahl, and the Mayor of the city of St. Paul, John J. McDonough.*



Hour Station' WMIN

FIG. 4. *WMIN's Control Room showing their RCA 76-B2 Console and 70-C2 Turntables.*



At last... AN "FM QUALITY" SPEAKER

New LC-1A Monitoring Loudspeaker has uniform frequency response and low distortion from 50 to 15,000 cycles

by

G. E. Rand

Broadcast Audio Section
Engineering Products Department

The long-awaited LC-1A Duo-cone Loudspeaker is now a reality! Shipment of speaker mechanisms started in July and shipment of cabinet models will be underway as you read this issue of BROADCAST NEWS. (If you read it while at the NAB Convention, you can see the LC-1A in our Exhibit Booth.)

The LC-1A Loudspeaker (Figure 1) is the commercial model of the much-discussed "Olson Speaker," which many broadcasters have heard and acclaimed at the RCA Laboratories during the past year. It is the direct result of extensive theoretical and structural investigation of wide-range, low-distortion speakers, performed at the RCA Laboratories by Dr. H. F. Olson and J. Preston.¹ Their work established the superiority of the duo-cone principal and led to the embodiment of this new type of construction in the LC-1A, a deluxe-type speaker especially designed for broadcast monitoring purposes.

The LC-1A Loudspeaker will be of particular interest to FM stations because its introduction makes available, for the first time, a monitoring unit of real "FM quality"—i.e., capable of uniform, low-distortion response over the whole 50-15,000 cycle range. From the earliest days of broadcasting the acoustical channel has been the weakest link (from the point of fidelity) in the broadcast system. The problem of efficiently converting electrical energy to acoustical energy (or vice versa) over the required frequency range has always been a difficult one. The advent of FM, with its goal of "15,000 cycle response," has made it even more difficult. Fortunately, there was available a microphone—the RCA Velocity Microphone—which was capable of reproducing the whole 50 to 15,000 cycle response with high fidelity. There was not, however, a commercially-available loudspeaker of equivalent quality. The introduction of the LC-1A remedies this defect by making available, for the first time, a loudspeaker of quality and range comparable to that of the best studio-type microphones (the 44-BX and the 77-D). It is interesting to note that Dr. Olson, who developed the first velocity microphones, is also the originator of this new speaker.

Fundamentally, the LC-1A Duo-cone Loudspeaker is a 15-inch permanent-magnet type mechanism (Figure 2), employing the

¹ "Wide-Range Loudspeaker Development," by Dr. H. F. Olson and J. Preston, RCA REVIEW, Vol. VII, No. 2, June 1946.

FIG. 1. (Right) The LC-1A is available either unmounted (as in Figure 2) or mounted in the attractive cabinet shown here. This cabinet, which comes in two-tone umber gray (RCA standard) or fine walnut veneer, was especially designed for use with this new unit. It is 40 $\frac{3}{8}$ " high, 27 $\frac{1}{8}$ " wide, and 15" deep.

highest grade Alnico magnets. The cones are of the direct-radiator type and consist of high- and low-frequency units mounted coaxially together as shown in Figure 3. The two cones share the same axis and cone periphery angle.

HIGH-FREQUENCY CONE

The high-frequency unit is a 2-inch cone with an aluminum wire-wound voice coil, effecting a very desirable high flux density and a low mass necessary to obtain the extended high-frequency range reflected in Figure 4. To propagate the acquired high-frequency range in a wide and uniform directional pattern in both vertical and lateral planes, has been the problem of speaker



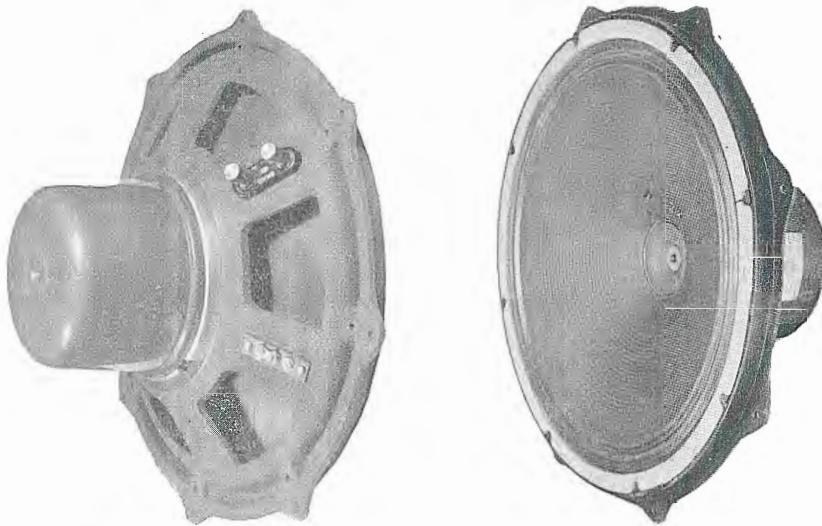

FIG. 2. Rear and front views of the LC-1A Loudspeaker mechanism. This speaker consists of a 15" low-frequency cone, which is mounted at the center of the larger cone, as shown in the illustration at the right.

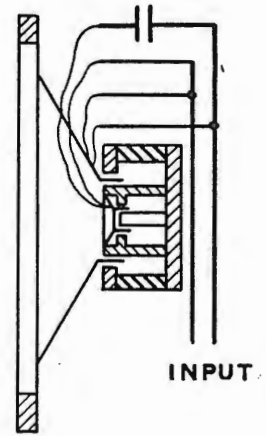

FIG. 3. Diagram showing relative mounting of the two cones in the LC-1A and the manner in which connections are made to the two-field coils.

design engineers for years. Various types of "tweeters" and horns have been devised to obtain this characteristic. Horns have probably been the most popular and widely accepted. However, cellular-type horns, resorted to for a wide lateral plane coverage, possess several inherent geometrical disadvantages and restrict uniform propagation. Although cellular horns provide up to 100° total angle in the lateral plane, the vertical plane coverage is usually limited to approximately 40°. Coherent with this disadvantage, this type of horn also produces a considerable change in the high-frequency response for various angles off the cone axis. To obviate these discrepancies the LC-1A utilizes the shallow angle of the low-frequency cone to effect its remarkable uniform pattern of 120° at 15,000 cycles (Figure 5). This outstanding feature has eliminated the usual "beam" effect so apparent when listening to the horn-type speaker and allows the listener a wide angle of reception. This feature presents a speaker particularly ideal for control room monitoring, etc., since a critical location is not required.

LOW-FREQUENCY CONE

The low-frequency cone employs a shallow-angle, massive 15-inch diaphragm with a high-mass voice coil to produce a most desirable low distortion factor, extended low-frequency range, and a low fundamental resonant frequency, which is approximately 35 cycles. Above this frequency the reluctance due to the mechanical compliance of the cone suspension system does not appreciably retard the movement of the cone and, therefore, minimizes distortion. Figure 6(a) shows the distortion curve for the LC-1A and Figure 6(b) that of a typical conventional type high-fidelity speaker. It will be noted that in the conventional speaker curve a large distortion content is present in the cross-over frequency region. This is mainly due to the electrical design limitations of the tuned filter circuit. The LC-1A has eliminated this by utilizing the physical disposition of the cones to mutually vibrate in unison over the cross-over region and merely employs one 4 mfd. capacitor to limit the low frequencies

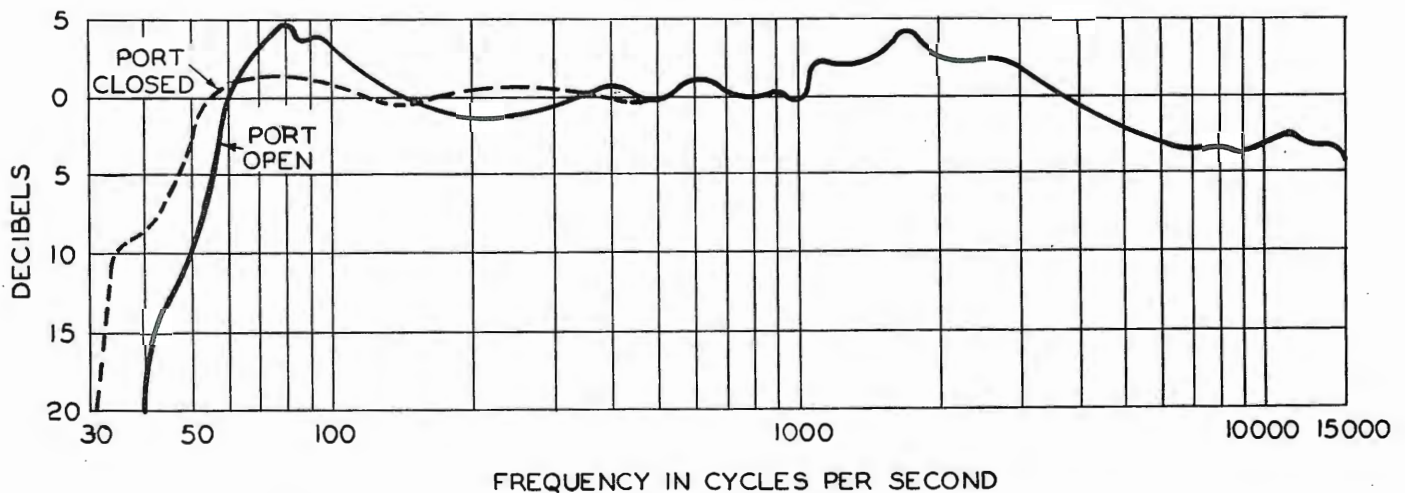

FIG. 4. Frequency response of a typical LC-1A Speaker with cabinet port open and closed.

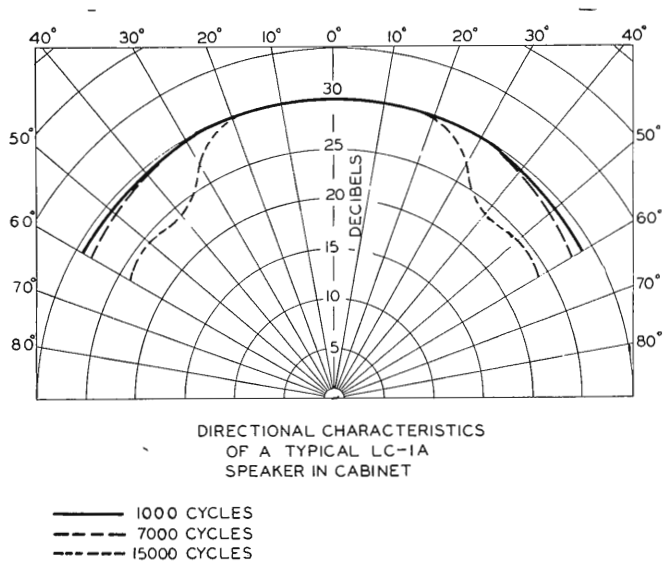

FIG. 5(a). Directional characteristics of the LC-1A Speaker at frequencies of 1,000, 7,000 and 15,000 cycles are shown in the diagram above. Note that the response is reasonably uniform over an angle of 120°.

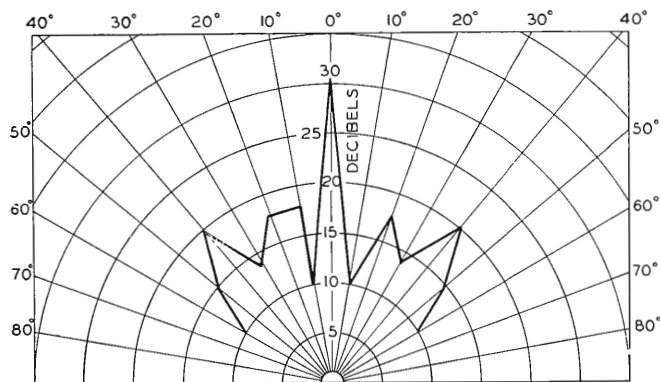

FIG. 5(b). The directional characteristic of a typical duplex-type speaker at 15,000 cycles is shown here for comparison. Note that because the horn used to obtain the high frequency response is very directional, uniform frequency response is obtained only for position directly in front of this type of speaker.

flowing in the high-frequency coil. This system not only affords low distortion, but also is a contributing factor to a smooth response over the mid-frequency range.

CABINET FEATURES

Just as listening tests on radio receivers have indicated a bass boost is conducive to pleasant listening, so have listening tests on the LC-1A confirmed the need for bass accentuation. To accomplish this, the LC-1A cabinet was specially designed with an open bass reflex port to give the most desirable bass accentuation for general acceptance (Figure 4). However, since some individuals prefer a flat, low-frequency response, the port may be easily closed to obtain a curve as illustrated by the dotted line in Figure 4. This curve also portrays the low-frequency response of the LC-1A when it is mounted on a flat baffle.

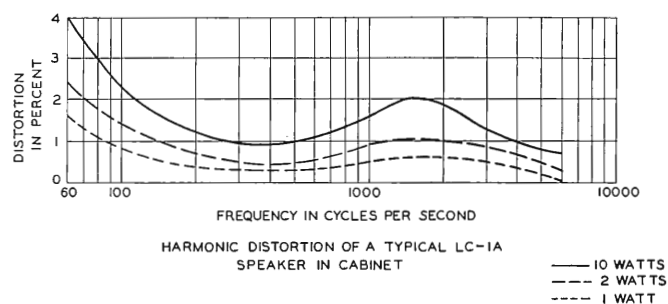

FIG. 6(a). This curve shows the distortion versus frequency characteristics of the LC-1A Speaker. Note that there is no sharp increase in distortion at any point and that its distortion over the whole measurable range is very low.

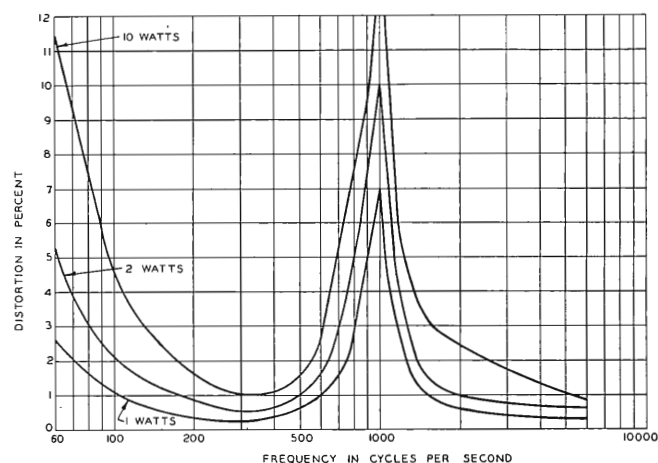

FIG. 6(b). Shown here are distortion curves for a typical "coaxial" type speaker of conventional design. Use of a cross-over filter causes high distortion in the cross-over frequency region. In the LC-1A this is avoided by elimination of the filter, a single condenser being used instead.

The cabinet of the LC-1A is attractively styled in two finishes—two-tone umber gray with satin chrome trim (MI-11411) to blend with all RCA equipment, and a bleached walnut veneer (MI-11411-A) for use in finely finished listening booths and executive offices, etc. Both cabinets are provided with a brushed-chrome control panel on the top right side. Mounting holes are available for an MI-11711 channel selector switch to connect the speaker to any one of 10 high-level audio busses. When this method of bridging is desired, the panel will also accommodate the MI-11708 15-ohm power attenuator.

OTHER FEATURES

For applications where it is necessary to operate the LC-1A as an independent unit bridging a low-level audio buss, a BA-4 series monitoring amplifier may be mounted in the base of the cabinet. The panel will then accommodate the MI-11711 channel selector switch kit, which includes an "on-off" switch and an

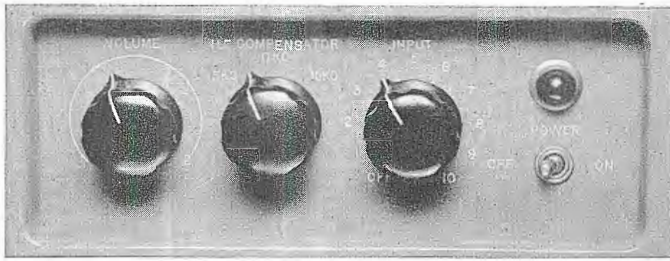

FIG. 9. Closeup of the control panel on the side of the LC-1A Speaker Cabinet. The H-F Compensator is furnished with cabinet units (but not with unmounted units). The volume control, selector switch, and on-off switches should be ordered separately.

associated visual light as shown in Figure 9. An MI-11707 high-frequency attenuator, which produces curves with a 5 and 10 kc "roll off" as indicated in Figure 7, is supplied as an integral part of each cabinet. (This attenuator is not supplied when the speaker mechanism only is ordered.) Listening tests indicated the necessity of this attenuator for most recorded material programs where high-frequency distortion inherently prevails. Ordinary home-type records appear to contain the highest distortion factor, requiring attenuation to permit pleasant listening. Some transcriptions also have a high distortion content sufficiently noticeable to warrant attenuation. However, when listening to live programs (especially FM), the LC-1A exhibits its superior qualities and is unexcelled as a high-fidelity speaker.

The mounting flange of the speaker mechanism is unusual, as may be seen from the photograph. The usual thickness of the baffle at the edge of the speaker is sufficient to cause marked irregularities in the high-frequency response due to reflection of the high frequencies at this point. The mounting flange design of the LC-1A should avoid this objection by allowing the edge of the cone to lie flush with the exterior of the baffle.

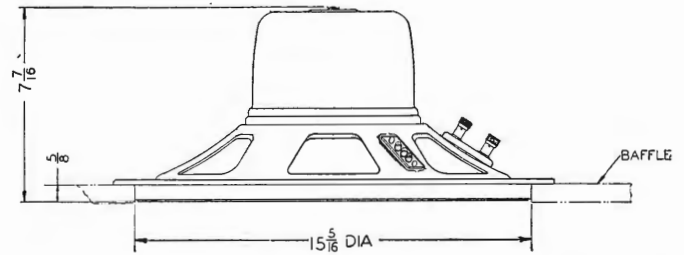
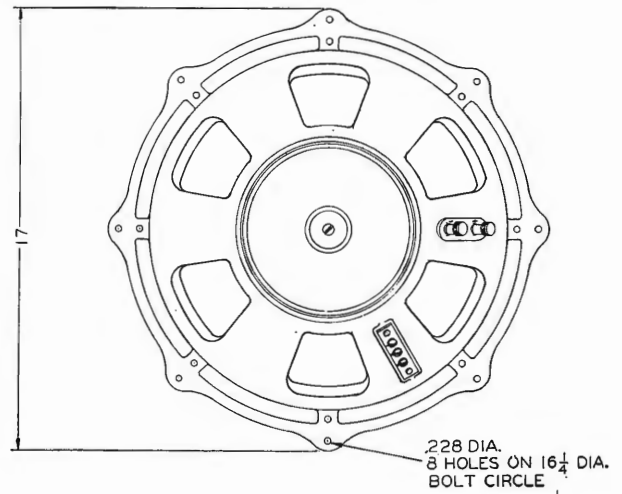

FIG. 8. Mounting dimensions for the LC-1A mechanism. Note the relatively thick mounting flange which is provided so that the thickness of the baffle board will not cause irregularities in the high-frequency response.

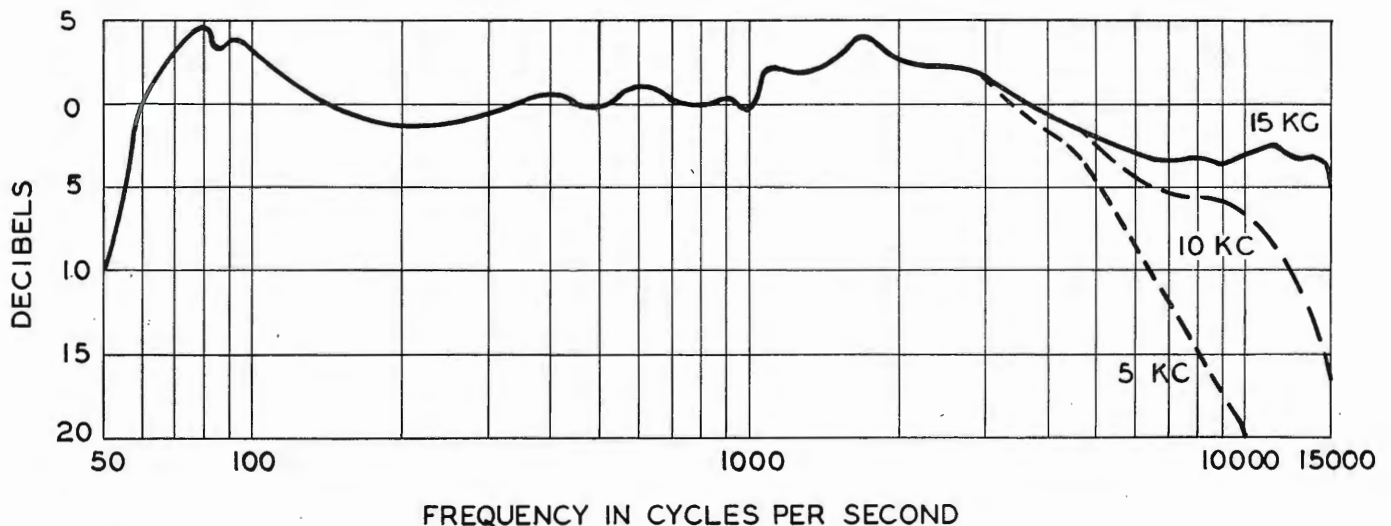

FIG. 7. Frequency response of the LC-1A Speaker (mounted in cabinet) for the three settings of the H-F Attenuator.

FREQUENCY RANGE PREFERENCE FOR SPEECH AND MUSIC

by

HARRY F. OLSON

RCA Laboratories, Princeton, N. J.

INTRODUCTION

Subjective tests of frequency range preference of reproduced sound have been made by various organizations¹ from time to time. These tests appear to indicate that the average listener prefers a restricted frequency range in monaural reproduced speech and music. There are three possible reasons for the results of these tests, as follows: A. That the average listener, after years of listening to the radio and the phonograph, has become conditioned to a restricted frequency range and feels that this is the natural state of affairs. B. That musical instruments are not properly designed and would be more pleasing and acceptable if the production of fundamentals and overtones in the high frequency range were suppressed. C. That the distortions and deviations from true reproduction of the original sound are less objectionable with a restricted frequency range. The distortions and deviations from true reproduction of the original sound are as follows:

1. Amplitude distortion.
2. Nonlinear distortion.
3. Spatial distribution.
 - a. Relatively small source.
 - b. Separated sources in two-way loud speaker system.
 - c. Nonuniform directional pattern with respect to frequency.

4. Single channel system.
5. Phase distortion.
6. Transient distortion.
7. Microphone placement and balance.
8. Acoustics of two rooms; the pickup studio and the listening room.
9. Limited dynamic range.
10. Difference in level of the original and reproduced sound.
11. Noise.

In order to obtain a better understanding of the reason for the preference of a restricted frequency range in reproduced sound, a fundamental all-acoustic test of frequency range preference was made. A small orchestra was used for the source of sound in this test. An acoustical filter was placed between the orchestra and the listeners and arranged so that the filter could be turned in or out. These tests have been in progress for over a year. It is the purpose of this paper to describe an all-acoustic frequency preference test and to give the results which have been obtained.

ROOM

The floor plan of the room and the general arrangement of the test is shown in Figure 1. This room was designed to be the acoustical equivalent of an average living room.² The room is 24 feet long, 20 feet wide and 9½ feet high. The room is partially finished in acoustical plaster backed by 2 inches of rock-wool. The ducts shown in Figure 1 are covered with a standard absorbing material. An abuse resisting wainscoat of hardboard extends up four feet from the floor. Drapes are also used to cover a part of the wall surface.

¹ Chinn and Eisenberg, Proc. I.R.E. Vol. 33, No: 9, p: 571, 1945: The tests reported in this paper were not made with the intention of disproving tests on monaural reproduced sound. As far as the author is aware, the results of this test are not in conflict with any other published or reported tests.

² The number of person-listening hours spent in the home in listening to radio and phonograph sound reproduction exceeds the time of all other types of reproduced sound outside of the home by a factor of many times. Therefore, an average living room was used for these tests because one of the objects was to determine listener frequency range preference in a small room.

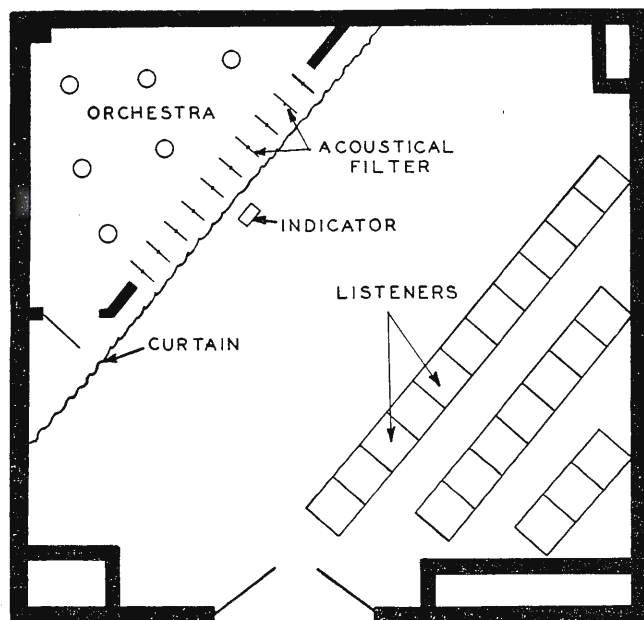

FIG. 1. Floor plan of the room used in making the "all-acoustic" tests described in this article. Acoustical filter (see Figures 4 and 5) is hidden from listeners by a curtain so that it is impossible for them to tell visually in which position the vanes are at any time.

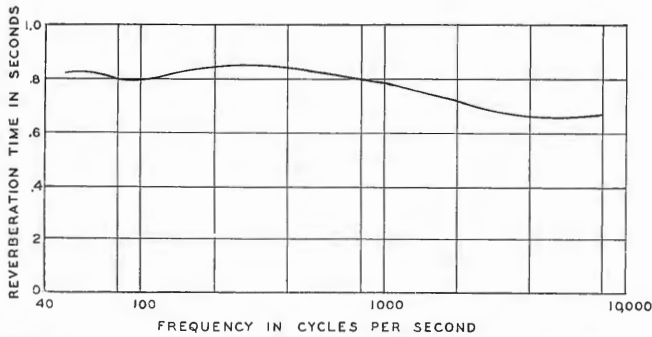

FIG. 2. Reverberation time-frequency characteristic of the test room.

The reverberation time frequency characteristic of the room is shown in Figure 2. This characteristic approximates that of a typical living room of this size in a home or apartment.

The average ambient noise level in the room without the orchestra or listeners is 30 decibels.

ACOUSTICAL FILTER

The acoustical filter used in these tests consisted of two sections. A sectional view and the acoustical network of the acoustical filter are shown in Figure 3. The filter was made in the form of elements 1 foot wide by 8 feet in length. These elements were pivoted at the top and bottom so that the filter could be

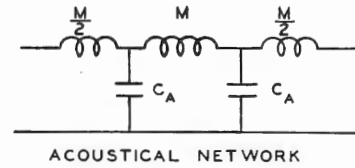

ACOUSTICAL NETWORK

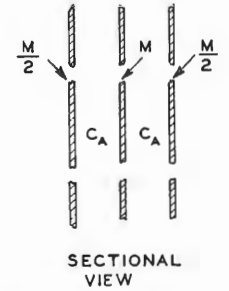

SECTIONAL VIEW

FIG. 3. Equivalent schematic and sectional view of acoustical filter.

placed in or out of operation by turning the entire group of elements by means of a lever, as shown in the photographs of Figures 4 and 5. Overlapping strips backed with felt gaskets together with weights insured a soundproof joint with the filter in the operating position. The response-frequency characteristic of the filter is shown in Figure 6. It will be seen that the cutoff is quite sharp. The response-frequency characteristic³ of the

³ In radio receiver or phonograph terminology the response-frequency characteristic shown in Figure 6 would be considered to be 5000 cycle transmission. In filter terminology, the cutoff occurs when $z_{A1} = 4z_{A2}$, where z_{A1} and z_{A2} are the series and shunt acoustical impedances of the filter. Using this formula, the cutoff frequency is 4000 cycles. However, in this paper we will designate the response as 5000 low pass transmission in keeping with radio and phonograph terminology.

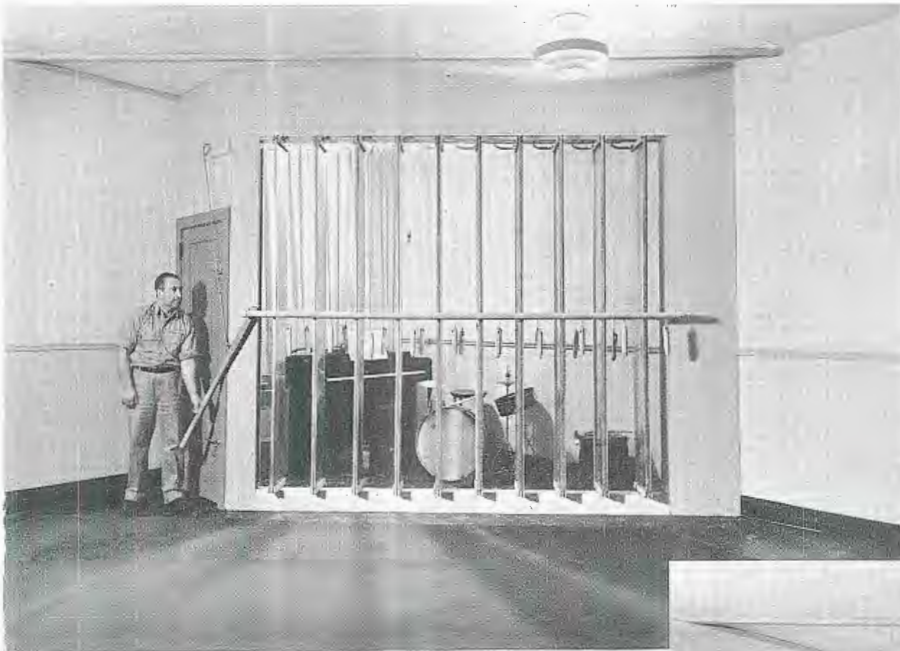

FIG. 4. (left) The acoustical filter consists of eight vanes each 1 foot wide by 8 feet high. These are pivoted at top and bottom so that the whole group can be turned in or out by operation of the lever as shown here.

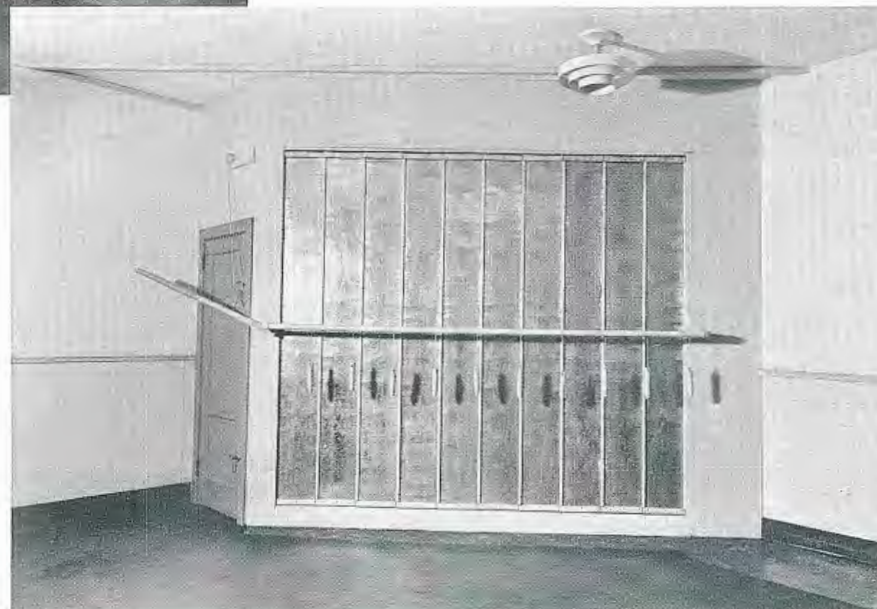

FIG. 5. (right) This view shows the vanes in the closed position (i.e. to cut off at approximately 5000 cycles as shown in Figure 6). Overlapping strips with felt gaskets, together with weights, insure a soundproof joint.

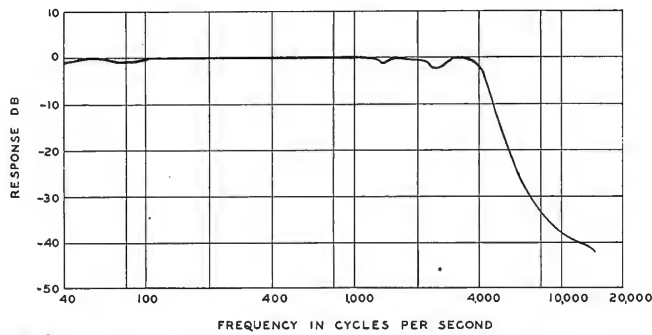

FIG. 6. The response-frequency characteristic of the acoustical filter.

filter approximates a very good commercial radio or phonograph reproduction in the high-frequency range.

A cloth curtain is used to cover the filters so that the listeners cannot see what transpires behind the curtain, as shown in the photograph of Figure 7. The response-frequency characteristic of the cloth curtain is shown in Figure 8. The loss introduced by the cloth curtain is negligible.

The particular condition, that is the full frequency range or the 5000 cycle low pass transmission, is depicted on an A-B indicator shown in the photograph of Figure 7.

ORCHESTRA AND MUSIC

The orchestra used in these tests was composed of six semi-professional musicians. The following instruments were used: piano, trumpet, violin, clarinet, contrabass, drums and traps.

Popular music⁴ was used for a major portion of these tests. The musical numbers used were "Smoke Rings" and "Blue Skies." The orchestra was balanced for the most pleasing condition. The balance⁵ was checked by competent musical directors.

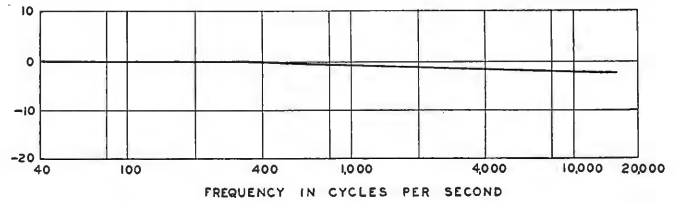

FIG. 8. Response-frequency characteristic of the cloth curtain. Loss introduced by this curtain is negligible.

⁴ Popular or light music was chosen as the material for this test because it is preferred by the greatest number of radio and phonograph listeners. For example: in the case of radio time, the relative percentages are as follows: popular music 72 percent, semiclassical 19 percent and classical 9 percent. In the case of phonograph records, the relative percentages are as follows: popular music 75 percent and semiclassical and classical 25 percent. Since radio time and phonograph record sales are based on public preference, it is quite evident that popular music is preferred by the greatest number of listeners. Therefore, since the greatest listener-preference is for popular music, it seems logical to employ popular music for the initial frequency-preference tests.

⁵ Some investigators have attributed considerable importance to balance in reproduced sound. Correct balance is said to obtain when the product of the upper and lower limits of the frequency range is 500,000 (cycles)². Some checks were made on the effect of balance in the tests described in this paper. An analysis of the components under the full frequency range indicated high amplitude components from 30 cycles to 17,000 cycles. This corresponds to a product of the upper and lower limits of the frequency range of 510,000 (cycles)². In order to obtain approximately the same balance for the restricted high-frequency range condition, the frequency components below 100 cycles were eliminated or attenuated. A comparison of this condition, with merely attenuating the high frequency range, showed a greater listener preference for the latter condition. This is in spite of the fact that the latter condition is said by some critics to be improperly balanced. Under certain conditions, there appears to be other factors which influence the balance, besides an arbitrary value for the product of the upper and lower limits of the frequency range.

FIG. 7. Cloth curtain in front of filter prevents listeners from seeing position of the vanes.



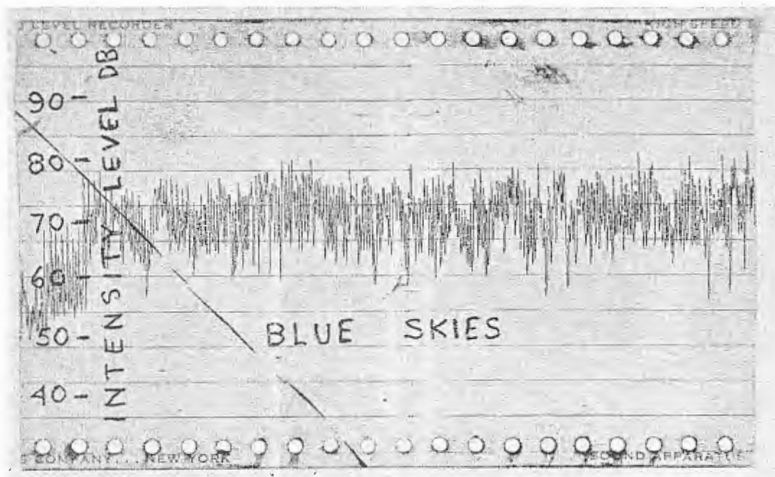

FIG. 9. Instantaneous sound intensity level diagram for a portion of "Blue Skies," which was one of the numbers used.

A peak sound intensity level of 70 to 80 decibels appears to be the most pleasing level for serious listening to music in a small room. One of the most difficult problems was that of obtaining this low peak sound intensity level in the small room. Considerable practice was required before the orchestra could perform in a satisfactory manner at this relatively low sound intensity level. In a large auditorium a much higher sound intensity level would be more pleasing. An instantaneous sound intensity level diagram, taken with a high speed level recorder on a typical portion of "Blue Skies," is shown in Figure 9. The average peak sound intensity level on a standard level indicator⁶ during this interval was 75 decibels.

LISTENERS

The listeners were selected from visitors and personnel of the RCA Laboratories. The following professions and trades were represented: physicists, chemists, engineers, doctors, lawyers, bankers, farmers, model makers, secretaries, housewives, office workers, janitors, millwrights, electricians, stenographers, gardeners, high school and college students, teachers, etc.

TEST PROCEDURE

The listeners were brought into the room and given the card depicted in Figure 10. The listeners were given instructions as

⁶ Chinn, Gannett and Morris, Proc. I.R.E., Vol. 28, No. 1, p. 1, 1940.

FULL FREQUENCY RANGE
 5000 CYCLE LOW PASS

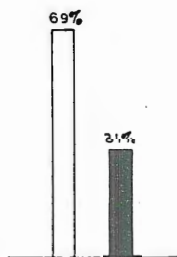

FIG. 11. Aggregate results of tests (in which over 1000 listeners participated) when a popular selection was played.

FULL FREQUENCY RANGE
 5000 CYCLE LOW PASS

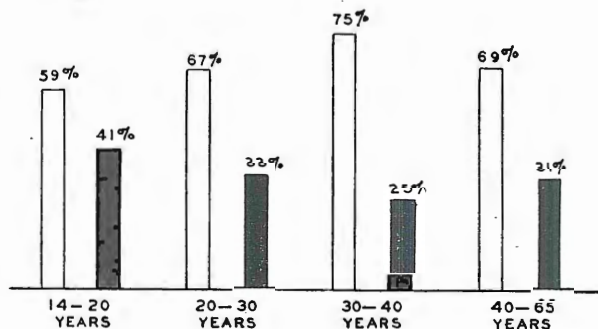

FIG. 12. Results for a group of 500 listeners who were divided into age groups.

FULL FREQUENCY RANGE
 5000 CYCLE LOW PASS

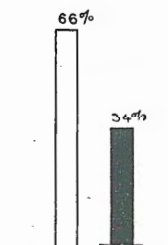

FIG. 13. Result when the orchestra played semi-classical music instead of popular type. Difference is negligible.

OCCUPATION	REMARKS
<input type="checkbox"/> MALE <input type="checkbox"/> FEMALE	
YOUR CHOICE <input type="checkbox"/> A <input type="checkbox"/> B	

FIG. 10. This is a replica of the card given visitors. They were told only that there would be two conditions (which would be changed at intervals) and were asked to indicate which of the two they preferred.

follows: They were told that there was a source of music behind the curtain. That there would be two musical selections, namely: "Smoke Rings" and "Blue Skies." That this music would be rendered under two conditions, namely, A and B as given by the A-B indicator.⁷ That the conditions would change about every fifteen seconds from one condition to the other as given by the indicator. They were asked to vote for the particular condition which they preferred, that is, either A or B. If everyone understood the test and there were no questions, the orchestra was given the signal to proceed with the rendition of the two numbers. As mentioned previously, the change from full frequency range to 5000 cycle low pass was made every fifteen seconds. When the orchestra had finished the two numbers, the listeners were asked to indicate their preference on the card, together with any comments.

RESULTS

Over 1000 listeners participated in these tests. The aggregate results of all the tests are shown in Figure 11. It will be seen that there is a preponderant preference for the full frequency range. In this connection, from the comments received, it was estimated that a considerable portion of the listeners who voted for the 5000 low-pass condition did not like popular music or

⁷ The letters C and D were also used without any apparent effect. The relation of A and B to the conditions were also interchanged in some of the tests.

the musical rendition. Under these conditions, it appears that anything that ameliorates the undesirable effects would be preferred.

The data depicted in Figure 12, in which the listeners are divided into age groups, comprised about 500 individuals. It will be noted that the age group 14 to 20 years shows a decreased preference for the full frequency range as compared to other age groups. The listeners in this age group are probably influenced by listening to radios, phonographs and juke boxes rather than orchestras and are, therefore, conditioned to a restricted frequency range. In spite of this conditioning, there is a preference for the full frequency range.

The results of the tests described in the preceding part of this paper were obtained with a small dance band playing popular music. In view of the adverse comments on the popular music made by some who voted for the restricted range, it was decided to make a check on a different type of music. It is, of course, impossible to conduct a test in a small room with symphonic music. However, in order to obtain some idea of the effect of the type of music, a test was made in which the orchestra played a semi-classical selection. The results of this test are depicted in Figure 13. For all practical purposes, the results of this test are in agreement with those obtained in the popular music test. As in the case of the popular music, adverse comments on the rendition and the type of music were made by the individuals who voted for the restricted frequency range.

SPEECH

Tests have been made on speech in which the individuals were familiar with the speaker's voice. Under these conditions, the listeners felt that there was a detrimental change in the voice when the frequency range was restricted to the 5000 cycle low pass transmission.

In tests in which the individuals were not familiar with the speaker's voice, the majority voted for the full range. The comments on the restricted range were as follows: "Muffled", "muddy", "mushy", "lacking in intimacy", "pushed back", "not as intelligible", etc.

CONCLUSION

The results of these tests show a preponderant preference for the full frequency range. This is not surprising because the restricted frequency range impairs the fine overtone structure which is the characteristic that distinguishes the various instruments in an orchestra. When the music was rendered with the restricted frequency range, most of the comments obtained from the listeners related to the destruction of the overtone structure of the violin, trumpet and clarinet. The snare drum seemed to be an entirely different instrument when the frequency range was restricted. With a restricted frequency range, the cymbals seemed to be two feet in diameter and one-eighth in thickness instead of the fine sound of a thin resonant disc.

The results of this test do not coincide with most of the results obtained on reproduced sound. In the case of reproduced sound, there appears to be a preference for a restricted frequency range. The results of the test reported in this paper appear to rule out the first two reasons for the preference of a restricted frequency range in reproduced sound outlined in

the Introduction, namely: A. That the average listener after years of listening to the radio and phonograph has become conditioned to a restricted frequency range and feels that this is the natural state of affairs. The results reported in this paper indicated that there may be a tendency for this factor to have some influence, but it is of small significance since there was, under all conditions, a preference for the full frequency range. B. That musical instruments are not properly designed and would be more pleasing and acceptable if the production of fundamentals and overtones in the high frequency range were suppressed. In addition to the results of this test, if this were the case, it seems quite possible that the savants of musical instrument design would have found a way of reducing the high frequency response, since the instruments have been under development through the ages. There remains one other reason for a preference of a restricted frequency range in reproduced sound; namely, the distortions outlined in the Introduction. Further work, with the object of obtaining more information on this rather elusive subject has been planned. The nature of the experiments will be outlined in the section which follows.

FURTHER WORK

In order to obtain further information on the general subject of sound reproduction, we propose to perform additional subjective experiments as follows: A comparison of full frequency range with 5000 low pass frequency range in stereophonic reproduced sound. A comparison of stereophonic reproduced sound with single channel reproduced sound. A comparison of full frequency range with 5000 low pass frequency range in a single channel system.

A comparison of the full frequency range with a 5000 cycle low pass frequency range will be made using three channels and the same orchestra and music as used in the all-acoustic test described in this paper. In order to simulate the acoustics of the test described in this paper, the orchestra will be placed in the free field sound room. The orchestra will be transferred to the listening room by means of microphones, amplifiers, and loud speakers. This experiment should yield some information on the effect of distortion in the reproducing system, because except for microphones, amplifiers and loud speakers, the test will simulate the all-acoustic test described in this paper.

A comparison of reproduced stereophonic sound with reproduced single-channel sound will yield information on the effect of reasonably true spacial reproduction as contrasted with sound coming from a point source. There is no question but that the type of distortion⁸ introduced by a single-sound source plays an important part in the reproduction of music.

A comparison of reproduced full-frequency range sound with reproduced 5000-cycle low-pass frequency range sound will serve as a check on the remainder of the tests outlined above and similar tests made in the past.

The author wishes to express his thanks to Mr. John Preston for valuable aid in designing the filter and supervising the tests, to Dr. J. G. Woodward for conducting the orchestra and arranging the music, and to the members of the orchestra, Messrs. G. A. Arleth, C. A. Hurford, E. G. May, D. G. Murray, J. Preston, C. S. Windham and J. G. Woodward.

⁸ Fletcher, H., Proc. I.R.E., Vol. 30, No. 6, p. 266, 1942.

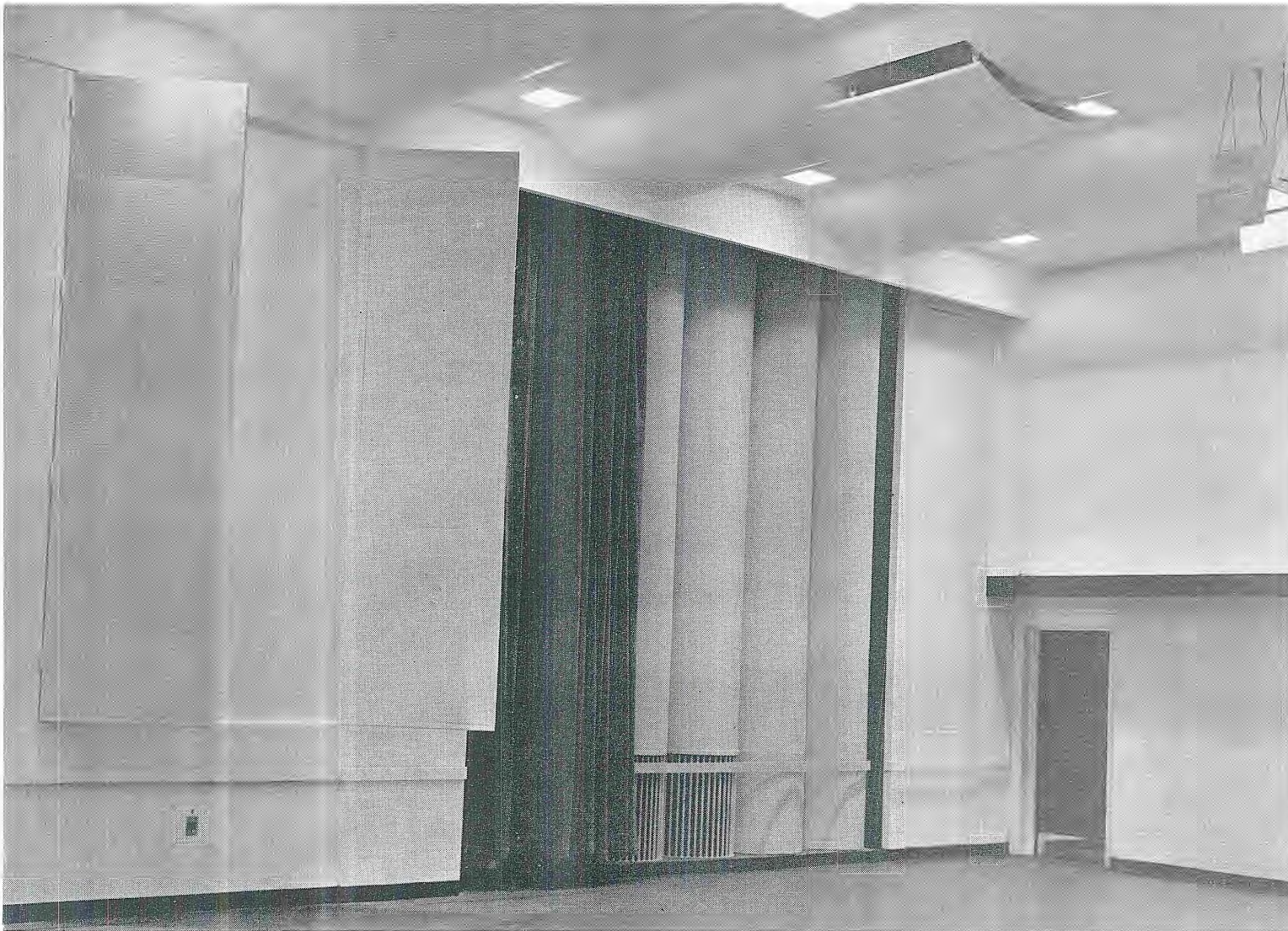

FIG. 1. A closeup view of the hinged acoustical panels in Studio 3A.

Recording Studio 3A

by G. M. NIXON

Engineering Department, National Broadcasting Company
New York, N. Y.

Summary—This article discusses the acoustical design problems in remodeling a studio for broadcast transcription and recording usage. The use of adjustable acoustical elements to provide a change in reverberation time of about 2:1 is covered and the description of the application of diffusely reflective surfaces in combination with absorbent areas for optimum acoustical results is included.

Recording Studio 3A, to be used jointly by the NBC (Radio Recording Division) and RCA Victor Division, was designed for recording both program transcriptions and records for home use, and placed in service in August 1946. It represents a modification of the former broadcast Studio 3A designed in 1933 when NBC first began operations in Radio City. The studio has a volume of approximately 68,000 cubic feet, a length of 80 feet, a width of 50 feet, and a height of 17 feet. Three views of the

studio are shown: a closeup of the control panels (Figure 1), the platform end (Figure 2), and a side view (Figure 3).

The acoustical problem in redesigning old Studio 3A for recording use was to provide as nearly as possible ideal acoustical conditions for performances of any type of program which was to be recorded and in which one to fifty performers would be participating. The ideals to be achieved for transcription type recording have been established by experience gained in broadcasting work wherein a transcription broadcast is simply a delayed transmission to the listener and must have the full qualities of a live program. Acoustical requirements for producing records for use in the home have also been determined through experience over a period of years.

The acoustical criteria for a studio designed for transcription purposes and one designed for recording records for home use, are somewhat different, largely as to the frequency-reverberation time characteristics. Transcriptions are designed to simulate broadcasts and for that reason acoustical conditions should be substantially the same as those employed in broadcast studios. A single broadcast program usually involves an appreciable percentage of speech—either announcements, talks or dramatic presentations—which require a somewhat non-reverberant acoustical condition to prevent an excessive amount of reflected sound from reaching the microphone and creating an impression of room size. On the other hand, the studio should be fairly

FIG. 2. (right) Looking toward the platform end in Studio 3A.



FIG. 3. (right) Another view of Studio 3A showing the arrangement of movable drapes and panels.



reverberant for the proper quality of music or other program material. In the broadcast studio these two requirements must be satisfied rather than compromised, since the latter course would result in unfavorable effects for both conditions.

The recording studio is concerned almost exclusively with music, and for that reason the problem is to provide the proper reverberation characteristic for the type and size of the performing group. However, when speech is recorded, control may be exercised by the use of sound-absorbent flats. In a recording studio, the use of the flats presents no problem of obstructing visibility, since no audience is present. In a broadcast studio, audiences frequently witness the programs and the control of acoustical conditions must be handled in a different way.

Studio 3A was designed so that the acoustical conditions could be altered to match the program. A consideration of several methods indicated that the most practical solution lay in the use of heavy-lined and interlined draperies, together with hinged acoustical panels as shown in Figure 3. The change in reverberation time was almost two-to-one, that is, at 1000 cycles, a change from 0.9 seconds to about 1.7 seconds. The use of heavy draperies hung some distance from the wall insured that the change would be effective even at the lower frequencies (see Figure 4).

The shape of the reverberation time frequency characteristic, selected as a design objective, is the one employed by NBC and

RCA in studio design in which the reverberation time below 500 cycles increases as the frequency decreases (see Figure 5). Experience has shown that this characteristic insures a proper tonal balance for both speech and music.

It was desired further that the reverberation time characteristic extend to as high a frequency as possible before falling off to insure the highest possible fidelity of recording. It is a well-known fact that the absorption of the air prevents appreciable control above 3000 cycles and, with a continued increase in the frequency, it becomes increasingly a larger factor than the absorption provided by the walls, floor and ceilings.

The selection of the reverberation time characteristics determines the total amount of absorbing material required, but does not indicate its distribution. Distributed acoustical treatment, combined with the use of diffusely reflective surfaces, produces a more diffuse sound field than is obtained in rooms with plane boundary surfaces with concentrated areas of acoustical treatment. Under the former set of conditions the exact location of the microphone has been found to be less critical for obtaining a good balance, thereby facilitating the obtaining of the highest quality of recording.

The emphasis in the design has been toward obtaining a very diffuse sound field. Where this conditions is realized, the importance of reverberation time is lessened; i.e., in a plane rec-

tangular room experience has shown relatively narrow limits of tolerance from an optimum reverberation time. Where the sound field is more diffuse, the upper limit of this tolerance may be raised appreciably with beneficial rather than objectionable effects.

The use of diffusing surfaces with interposed absorbing surfaces results in a very substantial increase in their absorbing efficiency which cannot be neglected in calculations. This is due partially to diffraction effects and to the better coupling of the absorbent medium to the air.

It was originally intended to employ a large amount of plywood on the wall and ceiling areas. Curved plaster surfaces were selected, however, in preference to wood in this case because of the necessity of not using critical materials. Experience thus far indicates that the diffusion is the major factor, and its manner of achievement is of lesser importance. It is not implied that plaster is a superior material to plywood, but rather that the shape of the diffusely reflective surface is of more importance than the material employed in forming that shape.

The major acoustical adjustment is obtained by means of draperies which are usually considered to be deficient in absorption at the lower frequencies (below several hundred cycles). The draperies employed were quite heavy, lined and interlined, being about 100 per cent full and placed about one foot from a diffusely reflective wall. This procedure tends to insure a more uniform absorption characteristic with the use of these draperies than the characteristic absorption curve of lighter weight drapery in which the absorption increases with frequency up to one or two thousand cycles and then tends to decrease. This uniformity of the change in reverberation time-frequency characteristic (Figure 4) between the most reverberant and the least reverberant condition can be easily seen. The measured reverberation time frequency characteristic also is shown in Figure 4 together with the optimum curve for broadcasting. It will be noted that in the most reverberant condition, the curve is considerably above the broadcast optimum. Further, as the draperies and hinged absorbent panels are exposed, the curve tends to be reduced to the same general extent at all frequencies, thereby maintaining a proper balance between low, medium, and high frequencies almost irrespective of the reverberation condition selected.

In this studio the floor is of concrete covered by battleship linoleum and is highly reflective to sound. At the platform end,

there are a series of steps, concave in plan, to permit arrangement of the performing group for usual microphone technique. These steps are augmented by wooden platforms, as required for individual or groups of performers in an orchestral or choral performance.

The ceiling above the platform, for a distance of 25 feet from the rear wall, is treated with a series of highly-reflective, curved plaster, quasi-elliptical shapes to reflect the sound diffusely and to deflect it generally outward into the studio. The remainder of the ceiling is treated with large, semi-cylindrical plaster forms extending the full width of the studio, interspersed with 3-foot strips of 1-inch rock wool blanket covered with perforated transite.

The rear wall at the platform end consists of a number of vertical semi-cylinders of different diameters. These may be covered by a heavy drapery so that wall is changed from a highly diffusely-reflective surface to a highly absorbent one.

The side walls at the platform end diverge outward from the rear wall with a series of large, vertical, convex plaster shapes which tend to reflect diffusely the sound outward. The remainder of the side walls are, in general, of curved plaster arranged to be covered by draperies. These draperies are arranged to fit into pockets formed by the curved sections of the wall itself or behind the flat pilasters on which are mounted the hinged acoustical panels.

It is planned to study the comments of users of the studio, and listeners of records made in this studio, with a view of establishing the optimum acoustical criteria for the recording of transcriptions and records for home use. These studies may indicate the desirability of some physical changes in the studio for certain types of recordings. Many coordinated opinions are necessary to support any statement that the collective judgment of listeners prefer one condition instead of another. There is no question, however, that the studio represents a distinct advance over former recording studio design and, it is believed, further usage will provide additional confirmation of that fact.

Acknowledgment is made of the contributions of Messrs. G. K. Graham and H. M. Gurin of the NBC Development Group and to Messrs. J. E. Volkmann and A. Pulley of RCA Victor Division for their work involving calculations, measurements and suggestions concerning Studio 3A.

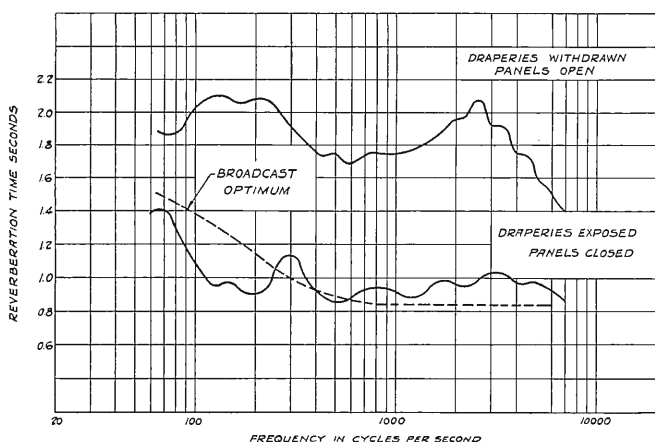

FIG. 4. Reverberation time-frequency characteristics.

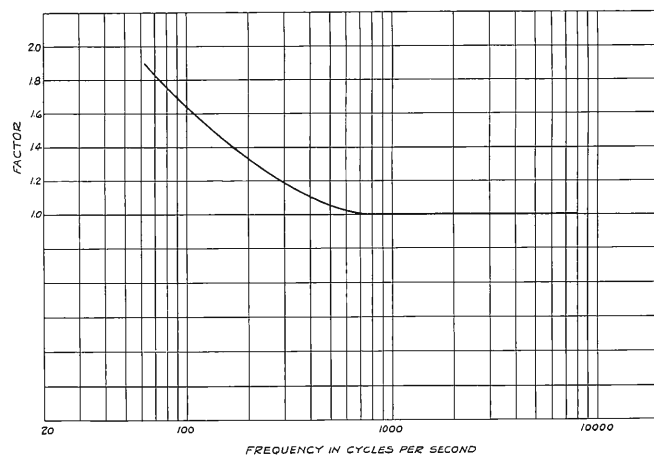

FIG. 5. Reverberation time-frequency ratio.



KOOL in Phoenix !!!

With programs of special Arizona interest and the educational and entertainment of nationwide Mutual and Don Lee Networks, Arizona's new radio station—5000 watt KOOL in Phoenix—went on the air at 960 kilocycles, Sunday, June 22nd.

Opening-day ceremonies, which included many special programs, began with an air welcome by Arizona's governor, Hon. Sidney P. Osborn; Phoenix' Mayor, Ray Busey; and officials of the Mutual and Don Lee Networks.

Lewis Allan Weiss, President of Mutual Broadcasting System, flew to Phoenix from Hollywood to be there for the opening-day activities. In a message to KOOL, Weiss hailed the new station as "a forward step in bringing the best of Mutual's radio entertainment for the first time to Arizona."

Facilities of the station—key outlet for the new Radio Network of Arizona (KCNA, Tucson is the first affiliate station, with others to follow this fall)—include modern offices and studios occupying three thousand feet of the lower level of Hotel Adams in downtown Phoenix. Entrance to KOOL is through an ultra-new archway of clean-cut glass blocks. A large observation window frames the outer glass-block wall; another large window enables visitors to see studio programs actually presented on the air. Offices are toned in cool pastels and paneled with sound-absorbent insets. KOOL's studios are columned with polycylindrical faces—to achieve greatest possible life-likeness in voice and music reproduction.

Another KOOL "first" (for this section of the Southwest) is the four-tower, directional antenna array, incorporating 256-foot towers covering a quarter of a mile in a straight line. An up-to-

the minute RCA Type 5-F Transmitter delivers an output of 5000 watts to this antenna arrangement, the first of its kind to be set up and used in this section of the United States.

Key staff officials of KOOL present an unusual concentration of radio-broadcasting knowledge and background. Over forty-five years total experience in the field is found in four department heads of KOOL—Verne Sawyer, Program Manager; Owen J. Ford, Chief Engineer; R. S. Bowen, News Editor; and Jimmy Murphy, Acting Station Manager. Owen J. Ford, Chief Engineer of Arizona's new radio station, is the proud father of five boys—which puts him one up on you know who. And Ford is only thirty years old!

The KOOL engineering head, questioned about his unusual family of five male heirs, explained it with an easy "one of those things" and laughingly said he was considering starting a basketball team when his boys are old enough. Ford, accustomed to handling large numbers of men as wartime deputy chief of communications for the OWI in China, finds his home job of father far more difficult.

"It takes more than 'orders from headquarters' to handle five boys," observed Ford, "and military government taught absolutely nothing about diapers, bottles and the sort."

Ford, a specialist in directional radio antenna equipment, such as the four-tower array being used for the first time in the far southwest by KOOL, has made a rather startling revelation to his friends.

Mr. and Mrs. Ford are expecting a new addition to their family soon—and they're actually hoping it will be a boy!

(Left): KOOL's transmitter is an RCA Type BTA-5F, mounted in the wall of the room.

(Below): KOOL's modern-in-every-detail transmitter building. Four-element directive array in the background.





FIG. 1. *Transmitter and control console of WFIL-TV (shown here) are located on the 18th floor of the Widener Building in downtown Philadelphia.*

WFIL'S TELEVISION PLANNING SETS FAST — PACE FOR NATION'S VIDEO STATIONS

PHILADELPHIA STATION NOW ON-THE-AIR AND WELL ALONG WITH NEW STUDIO BUILDING HAS ALSO ANNOUNCED PURCHASE OF THE ARENA, PHILADELPHIA'S LARGEST SPORTS CENTER, THEREBY ASSURING ITS LOOKERS-IN OF COMPREHENSIVE SCHEDULE OF OUTSTANDING SPORTS EVENTS

Within a matter of months, the call letters WFIL-TV have been sky-rocketed to a place among the leaders in the list of the nation's television stations. The history of The Philadelphia Inquirer's television station is as dynamic as it is brief. In a field where set patterns for station construction and program development still are relatively unknown, WFIL-TV has gone forward without hesitation and it is likely that its operation may do much to establish standards for television stations in the future.

A little more than a year ago, the proposed Inquirer outlet was assigned Channel No. 6 by the Federal Communications Commission. During the next few months, final plans were drawn up for the construction and operation of the station.

The real story of WFIL-TV progress begins in February, 1947, however. In that month the station placed orders with RCA-Victor's Engineering Products Department for its transmitter and its field and studio equipment. The achievements of the next six months constitute a tribute to the productive capacity of RCA and to the ingenuity of the WFIL management.

Heading up the WFIL-TV operation is Kenneth W. Stowman, Director of the station. Stowman, a veteran with twenty years in broadcasting, was formerly assistant to WFIL's General Manager, Roger W. Clipp. On the technical side is WFIL's Chief Engineer, Louis E. Littlejohn, and David J. Miller, Jr., Assistant Chief Engineer in charge of television.



BREAKING GROUND FOR NEW WFIL-TV STUDIO BUILDING. *Kenneth W. Stowman, Television Director of WFIL, breaking ground for the new WFIL-TV studio building at 46th and Market Streets as officials of the station look on. Grouped (left to right) are: Louis E. Littlejohn, Chief Engineer of WFIL; Roger W. Clipp, General Manager of WFIL; Walter H. Annenberg, publisher of The Philadelphia Inquirer; Stowman, and Joseph First, Inquirer Vice President. Ceremony took place on July 9th, less than a month after Mr. Annenberg had announced the purchase of the Arena, long-time Philadelphia sports center, by Triangle Publications, Inc.*

The first shipment of RCA equipment was transported by truck across the Delaware River Bridge, June 5, 1947. Installation began immediately on the 18th floor of the Widener Building, location of WFIL's AM and FM studios. When riggers hauled the three-bay antenna to the roof of the building July 12, the transmitter installation already was nearing completion. Self-styled experts who had scoffed at WFIL-TV's promise to be on the air "early this Fall" began to marvel at the progress.

On August 6 "on-the-air" tests began with test patterns from the monoscope camera. And during the first two weeks of September, WFIL-TV began regular programming with pickups from outside points including the Inquirer Charities' football game between the Philadelphia Eagles and the Chicago Bears at Franklin Field, on September 13.

In the meantime, WFIL-TV had been making comparable strides program-wise. The station was assured of some of Philadelphia's finest entertainment events, when, on June 11, Walter H. Annenberg, publisher of the Inquirer, announced the purchase of the Philadelphia Arena, at 46th and Market Streets. With the Arena went the television rights to the home games of the championship Philadelphia Warriors of the Basketball Association of America and the Philadelphia Rockets Ice Hockey Club. Each team plays an average of two home games a week

during the Winter months. The famous sports center also is the scene of the "Ice-Capades", "Ice Follies", the Shrine Circus, the Inquirer Tennis Tournament, and outstanding boxing and wrestling matches.

At the same time it was announced that WFIL-TV's studio building would be constructed adjacent to the Arena, and groundbreaking rites were held at the site July 9. Announcement that "the most modern structure in the nation built exclusively for television" would be completed and in use before the end of the year was surprising to no one by this time.

Meanwhile, Stowman revealed that WFIL-TV had lined up television rights to the home football games of Temple University and Villanova College; as well as the September 13 professional football game at Franklin Field between the Philadelphia Eagles and the Chicago Bears; plus the entire Philadelphia Eagles home game schedule. Thus, the station is assured of an outstanding schedule of television events long before the studio building is completed.

The eyebrow-raising point among all of WFIL-TV's accomplishments is that the station was telecasting its test pattern and conducting test program telecasts two months after its first piece of equipment was delivered. Simultaneously, an all-out promotional campaign was conducted to guarantee that set owners and

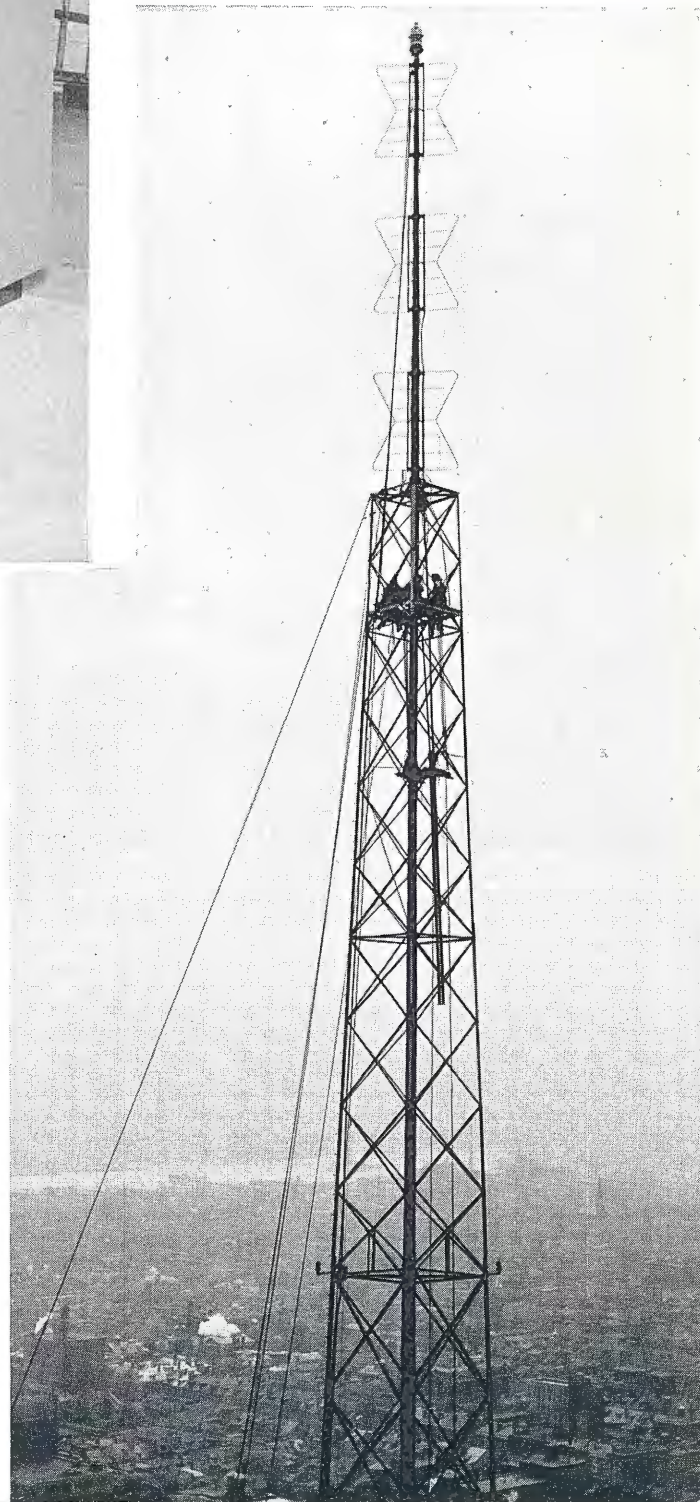

FIG. 2. (left) Shown here are, left to right, Mr. L. E. Littlejohn, Chief Engineer of WFIL (seated), Mr. Kenneth W. Stowman, Television Director of WFIL, Mr. T. A. Smith, General Sales Manager of RCA's Engineering Products Department, and M. A. Trainer, Manager of Television Equipment Sales for RCA. Mr. Littlejohn is manipulating the monitoring controls of the RCA TT-5A Transmitter at WFIL-TV.



FIG. 3. (left) This photo, taken before installation of equipment was completed, shows the position of equipment racks which are located just behind the control console (a corner of which is visible). On these racks are mounted the main synchronizing generator, monoscope camera, distribution amplifier, and power supplies.

FIG. 4. (below) WFIL-TV's antenna, a three-bay RCA Super Turnstile, is mounted on a 200' tower atop the 18-story Widener Building opposite City Hall in the very center of Philadelphia. Antenna is 502' above the street.



servicemen would make the necessary antenna adjustments before WFIL-TV began regular telecasting operations.

Here is a blueprint of WFIL-TV's operating setup:

STUDIOS AND OFFICES

WFIL-TV's studios and offices will be located in a new building which is now under construction and which will be finished this Fall. This building adjoins the Arena, Philadelphia's sports center, which as mentioned above has been purchased by the Inquirer. Thus, the Arena itself becomes, in effect, one of the main "studios" of WFIL-TV.

The new two-story building will house an AM studio as well as the TV studios and offices. The TV studios will be located on the first floor, which will also contain a projection room, TV control room, property shop, electronics shop, electrical equipment room, and the AM studio and control room. The TV studio, a large room 55' x 26', will be equipped with two RCA TK-10A Studio Cameras. The TV-studio control room, which is a smaller room, 25' x 16', will contain rack-mounted line amplifiers and power supplies, and a 5-monitor video console. Two of the five monitors in the console, display pictures from the two field cameras in the Arena; two are for the two studio cameras in the studio; and the remaining monitor will be used to display the video signal from the projection room.

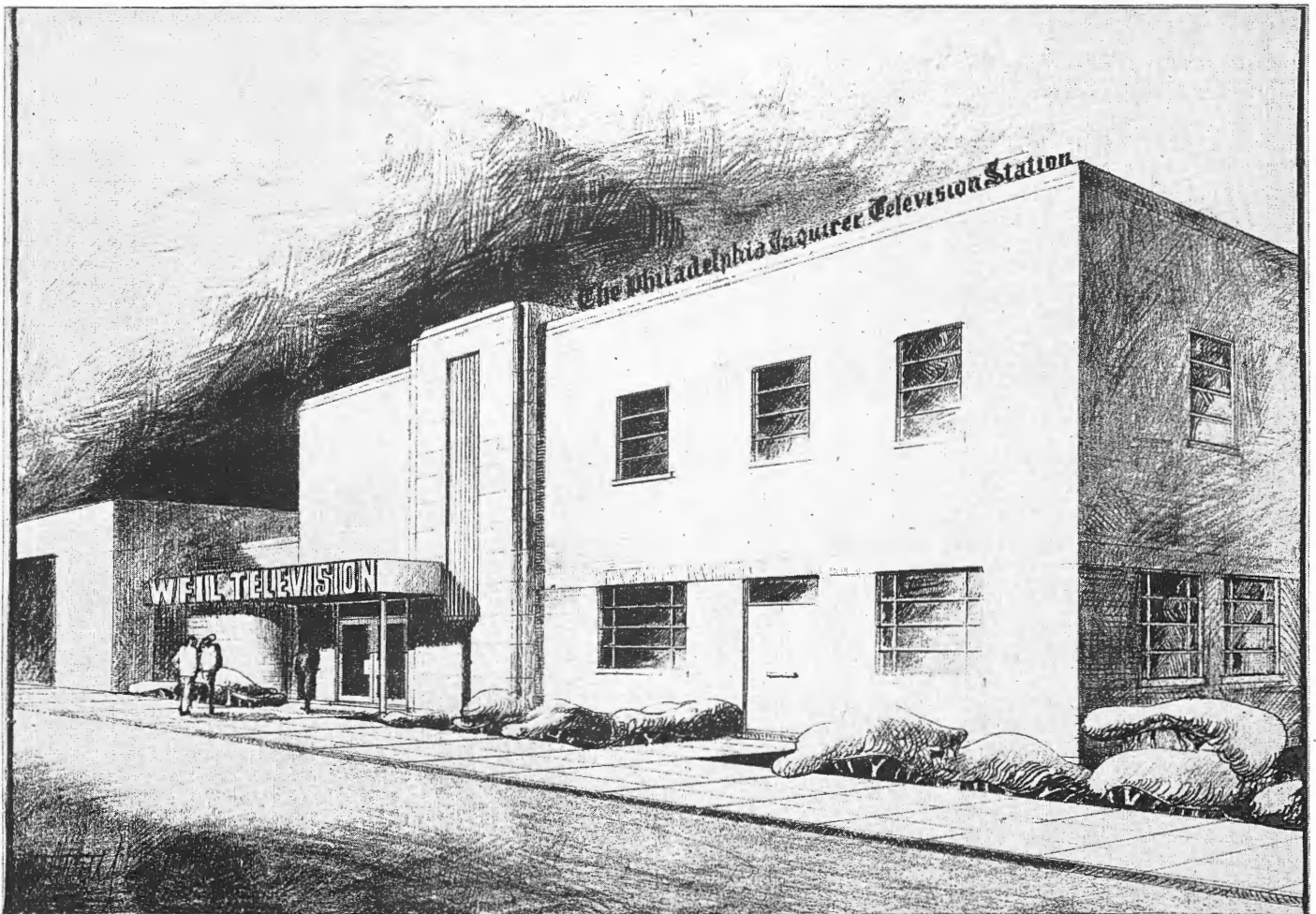

FIG. 5. This artist's sketch shows how WFIL-TV's new studio building will look when completed. Arena entrance is large door at far left.

In the adjacent Arena, two field Image Orthicon camera chains will be set up to cover events in the amphitheatre. The station also will have two field Image Orthicons with its complete RCA mobile television unit (of the type described on page 44). When the Arena cameras are not in action, they will make up an additional mobile unit. Thus the outlet always will be equipped to telecast two remote events in succession from any part of the city.

Another novel feature of the Arena setup will be special observation windows in the foyer of the Arena that will enable its patrons to view television and radio programs in production in the studios.

The station plans to use telephone lines to link the Arena studio with the transmitter in the Widener Building. Two microwave relay chains will be utilized to carry remote telecasts to the transmitter. Two receivers will be installed—one at the Widener Building, one at the Arena—and the remote pickup can be beamed to either receiver.

TRANSMITTER ROOM

The WFIL television transmitter is installed on the 18th floor of the Widener Building in an area adjacent to WFIL'S AM studios and FM transmitter. The television transmitter room is about 25' square and contains, in addition to the 5 kw television transmitter, a transmitter console, turntable, two 16mm projectors and film camera, vestigial sideband filter, dummy load cabinet, and cabinet racks containing the sync generator, line

amplifiers, monoscope camera, power supplies, etc. Designed for one-man operation, the transmitter console is equipped with two monitors instead of the usual one. This is a practical modification of the standard RCA Supervisory Control Console which other stations may find advisable to follow. The additional monitor affords the transmitter engineer an image of the incoming, as well as the outgoing signal. Or, the engineer may monitor the on-the-air telecast with one monitor while "previewing" an upcoming program (from another point) on the other monitor.

Incoming programs originating from either the studios or field mobile unit are picked up by the relay receiver located on the roof and fed to the console switching system in the transmitter room. The two RCA 16mm Projectors are set up with an RCA Multiplexer and a film camera. The Multiplexer is constructed with mirrors which allow the use of a single film camera for two projectors. All station breaks and signatures are made at the transmitter console.

The water-cooling system, which is required for the 8D21 output tubes of the transmitter, is located in an enclosure built on the roof beside the 200' antenna tower.

ANTENNA

The transmitting antenna is a 3-section Super Turnstile mounted 502' above the street. It is mounted on a 200' tower on top of the building. This antenna gives a gain of approximately 4.5, and thus used with the 5.5 kw TT-5A provides an average radiated power of approximately 24,000 watts.

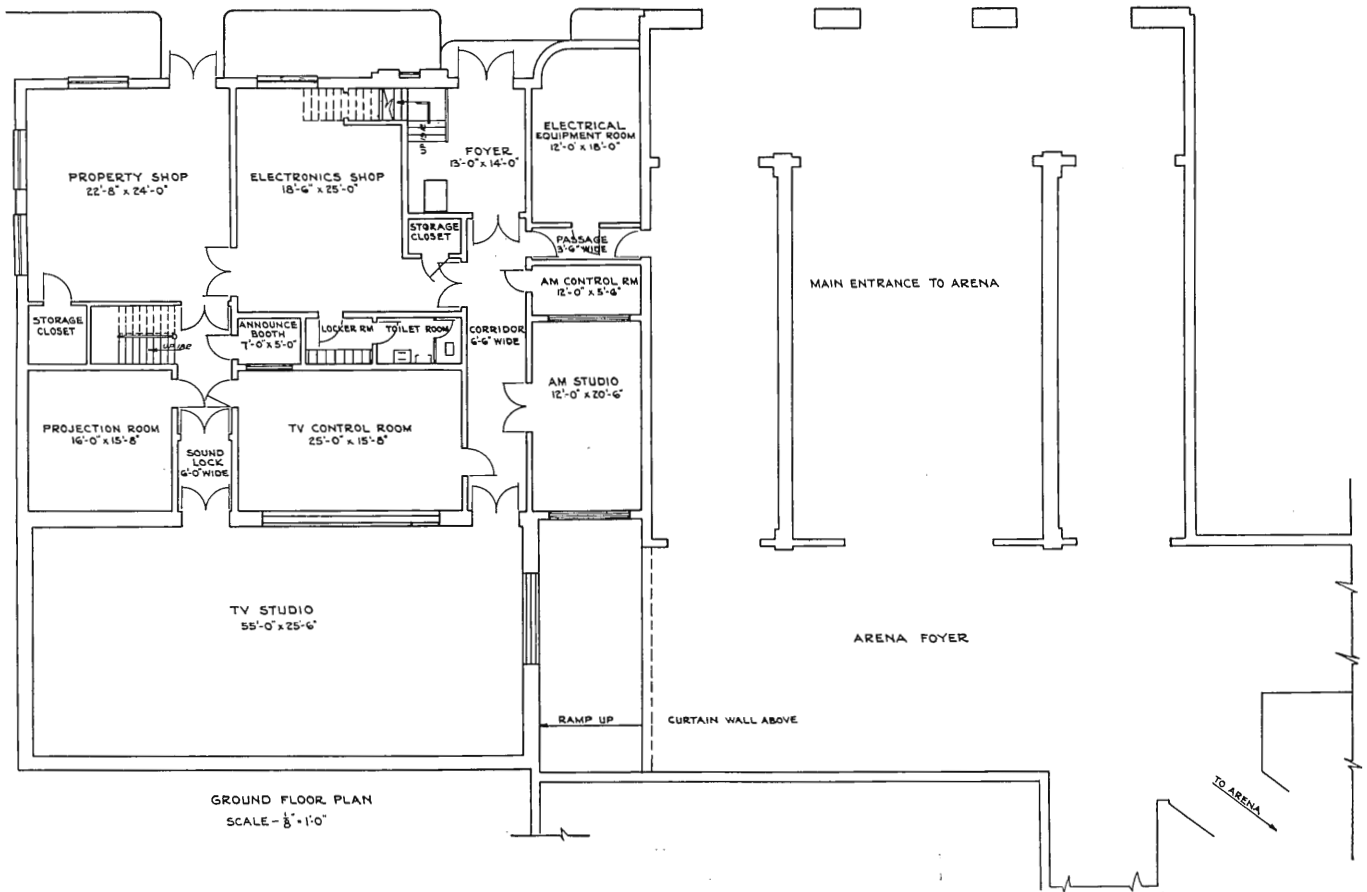

FIG. 6. (above) This is the ground floor layout of the new WFIL-TV Studio Building. Note window in the TV Studio through which visitors to the Arena will be able to watch television operations.

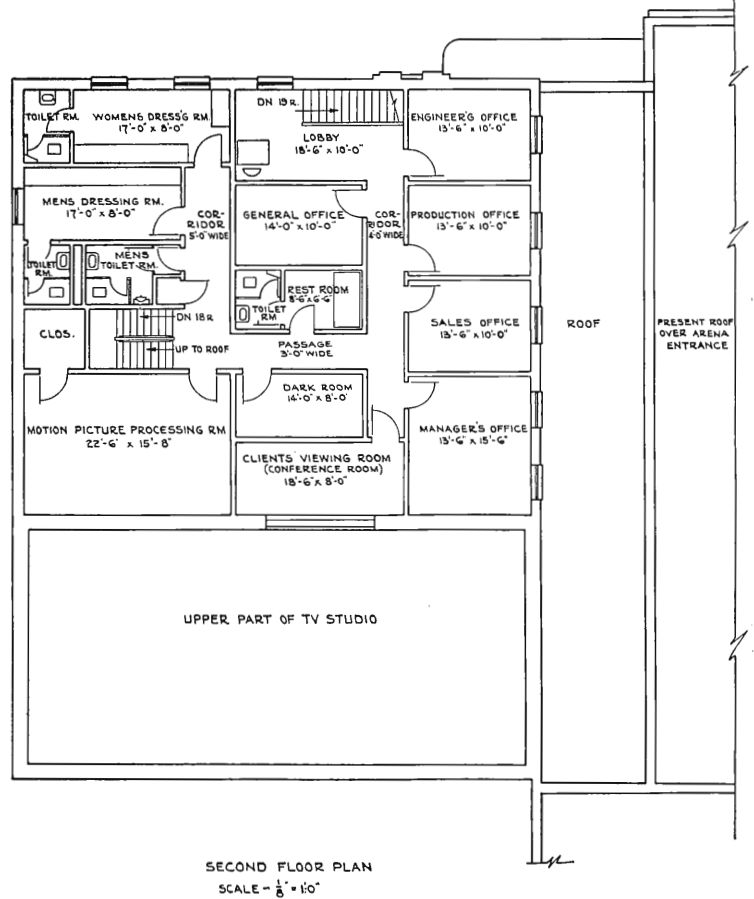

FIG. 7. (right) This is the second floor layout. General plan, it will be noted, places all mechanical and technical operations on first floor with programming production and business offices on second floor. TV studio proper is two stories high with client's room on second floor directly over the control room.



FIG. 1. The TJ-50A Mobile Unit (shown here at Camden Airport) provides both transportation and control space for standard field equipment. Cameras may be operated from the roof of the unit or placed as much as 1000 feet away.

THE RCA TYPE TJ-50A TELEVISION MOBILE UNIT

by
W. J. POCH and H. C. SHEPARD

Television Terminal Equipment Section
 Engineering Products Department

A study of the program schedules, issued by television broadcasters in operation at the present time, shows that the major program emphasis is on events which occur outside of the television studio. These events include baseball, football, boxing, wrestling, hockey, basketball, and numerous other similar types of program material. The success of this type of program can be attributed directly to the development of the RCA Image Orthicon,^{1,2} which permits the televising of pictures under light conditions unsatisfactory for other types of pickup tubes. Recognizing the importance of this type of broadcasting, the development program of our television terminal equipment group had as its first postwar objective the development of field equipment employing this new sensitive pickup tube. This equipment, generally referred to as the Image Orthicon Field Equipment, was described in the last issue of BROADCAST NEWS.³

There are, of course, several contributing reasons for the popularity of "outside" broadcasts by television stations. One reason is the fact that programs originating in the television studio require a large staff, an expensive studio layout, and relatively long rehearsal time. At the present time, while the television audience is still relatively small, it is hard to justify the expense incurred by an elaborate studio program. The other major source of television program material is moving picture film. It is expected that eventually there will be a great deal of film material suitable for television. At the present time, however, very little high-quality film is available for television use. Thus, of the three main types of programs, field pickups are presently the most attractive choice.

Because of this emphasis on broadcasting from locations outside of the television studio, the television group has now developed a mobile unit which is designed specifically for use with the Image Orthicon Field Equipment. The basic design consideration, upon which the development of this mobile unit (Figure 1) has been based, is the requirement that the unit be suitable not only for transporting equipment from one location to another but also for providing a convenient arrangement for



FIG. 2. *The TJ-50A Mobile Unit on State Street, Chicago. Standard relay transmitter may be mounted on roof of unit or anywhere within 400 feet. In this view it is placed on hotel marquee for sending video signals to receiver at WBKB on State-Lake Building, three blocks north.*

operating the equipment inside the mobile unit itself. In other words, the design emphasis has been on producing a mobile television control room. For a broadcast at any given location the cameras and the microphones must, of course, be taken from the mobile unit and placed in suitable positions for picking up the picture and sound signals for transmission. This also means that cables connecting the cameras and microphones to control units in the mobile unit must be provided. In addition it is necessary to supply sufficient a-c power and make arrangements for sending both picture and sound signals to the studio or transmitter location. By keeping most of the control equipment in the mobile unit it is possible to save a considerable amount of time in setting up the equipment in any given location. It follows, of course, that removing the equipment becomes an equally simple operation. Besides speeding up the "set-up" and "striking" time, this method of operation also reduces wear and tear on the equipment and saves considerable manual labor which would normally be required for carrying the equipment from the mobile unit to a suitable control location. It has also been found that in many places, where it is desired to originate

a television program, there is no suitable location for the control equipment. This should normally be a relatively small, quiet room which can be suitably darkened and from which casual visitors can be excluded. The control room arrangement in our mobile unit automatically provides these facilities.

It is recognized that in some cases it will be possible to park the mobile unit in such a location that the cameras can be connected with the camera controls by lengths of camera cable which are not excessively long. Tests, however, have indicated that we are able to use camera cable lengths up to 1000 feet without difficulty and in our opinion there will be very few locations where longer cable lengths will be necessary. In some television broadcast locations which are used frequently, it may be advantageous to install permanently a section of camera cable so that the time required for setting up the equipment can be still further reduced by eliminating the necessity for pulling in a long section of cable.

In discussing the above we have rather casually passed over two serious problems which face the broadcaster when he wishes



FIG. 3. (left) View inside the mobile unit, looking from the driver's seat toward the rear. Ladder, which provides easy access to the roof hatch, folds to ceiling when not in use. Cabinets at right provide carrying space for cameras, relay equipment, etc.

to pick up a program in the field. The first major problem is one of a-c power supply.

In designing our unit we at first seriously considered the possibility of including a gasoline engine generator which would furnish all power needed by the television pickup equipment. This, of course, has the outstanding advantage that at any location it is unnecessary to make arrangements for connecting to a power system. There are, however, some disadvantages to this method of supplying power. In normal studio operation it is common practice to lock the synchronizing generator with the power supply frequency so that the resulting vertical scanning frequency will be the same as the power supply frequency. This means that automatic synchronization of the television system can be obtained, when it is used in conjunction with film projectors, simply by using a synchronous motor drive on these

projectors. Another advantage of this method of operation is that any hum introduced into the system, either at the studio, transmitter, or receiver location, will automatically be stationary on the receiver and will therefore be relatively unnoticeable. When a frequency difference exists, hum is much more apparent. It is considered extremely doubtful that the frequency stability of the gasoline engine generator would be sufficiently good to allow the usual lock-in arrangement with the synchronizing generator in the mobile unit without causing an excessive frequency variation of the synchronizing signal. For this reason our synchronizing generator has been provided with a crystal which can be used to determine accurately the frequencies of the synchronizing pulses under conditions when the power supply frequency is not sufficiently stable. Even with the use of the crystal some difficulty is experienced because the frequency of the synchronizing pulses originating at the mobile unit will not correspond exactly, either in frequency or phase, with the signals originating at the television studios, since there is no electrical connection for synchronization between the two. This means that there will be some difficulty in obtaining a smooth transition when it is desired to switch between video signals originating at the mobile unit, and signals from a local studio. While equipment for making a smooth transition under these conditions will eventually be available the problem at the present time becomes much simpler if the equipment at the remote location and the equipment at the local studio are operated from the same power supply. For this reason we recommend obtaining power from the local power company whenever this is feasible. For those exceptional cases where it is not possible to obtain power by this method, we recommend the use of a two-wheel trailer carrying a gasoline-engine generator of sufficient capacity to supply the equipment (normally about 5 kw). This can easily be fastened to the rear of the mobile unit. This arrangement has the additional advantage that at any pick-up location the trailer can be moved manually a distance of several hundred feet from the mobile unit itself and in this way minimize the noise and vibration which most generators of this type normally produce.

The other serious problem, which faces the television broadcaster in the field, is the need for transmitting both the picture and sound signals to the studio or transmitter location. At the

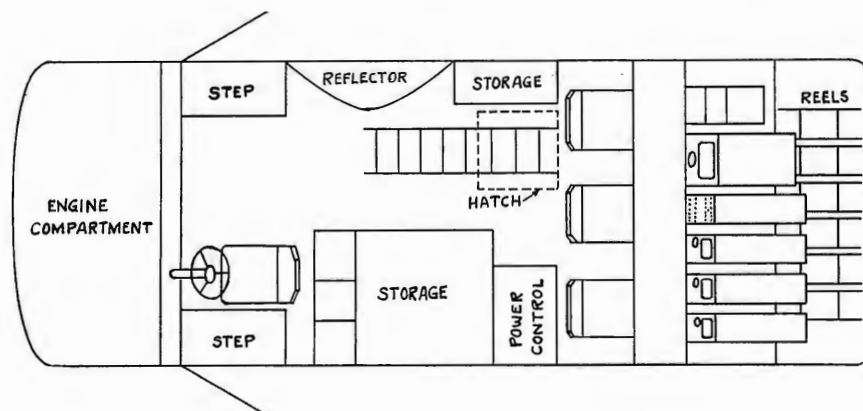

FIG. 4. (left) Floor layout of the TJ-50A Mobile Unit. Three seats face the operating table (at the rear) on which all of the control equipment is placed. Storage space contains shock mounts upon which cameras are placed during travel. Space is also available for the tripods, the relay transmitter and antenna, additional reels of cable, intercommunication equipment and other accessory items.

FIG. 5. (right, above) Operating position has seats for audio operator, director and video operator.

FIG. 6. (right, below) Equipment at control position includes audio units master monitor, switching unit and two-camera control units.

present time there are two methods for doing this. One is to use wire facilities provided by the telephone company, and the other is to use a suitable radio link. Which of these methods will eventually be in most common use is a question which cannot be answered at this time. In our opinion it will depend for the most part on the economics of the two methods as well as the attitude of the FCC toward this problem. In order to assist broadcasters in solving this problem, the RCA television group has designed microwave relay equipment operating in the band between 6800 and 7050 mcs.,⁴ specifically for the purpose of transmitting picture signals from a remote location to the studio or transmitter. This equipment requires line-of-sight between the transmitting antenna and receiving antenna and therefore presents the broadcaster with the problem of finding a suitable location at each transmitting point in the field so that line-of-sight to the receiver can be obtained. In some cases it will of course be impossible to obtain line-of-sight because of intervening buildings or unfavorable terrain. For these conditions it may be necessary to transmit the signal to the receiving location by using an intermediate relay point which is visible from both the remote point and the terminal point.

In order to simplify operation of the relay equipment it has been separated into two major units connected by a single cable. At the transmitting location, for instance, the antenna, with its parabolic reflector and the transmitter proper, may be mounted at as high an elevation as possible, while the control unit may be located at the same place as the other television control equipment. Cable lengths of several hundred feet may be used without difficulty. Since all control functions can be performed at the "ground" position, the same personnel operating the camera control equipment can also supervise the operation of the relay transmitter.

Figure 1 is an overall view of the completed mobile unit. The choice of this particular size was, of course, a matter of compromise. The parking problem for a larger unit or a trailer type would become quite difficult and a smaller unit would, in our opinion, have insufficient space. Since it is considered very desirable to be able to use the roof of the mobile unit as a camera or relay transmitter location, the roof area is also of considerable importance. It was also found that no great saving in cost could be obtained by using a vehicle of smaller size. The chassis used for this unit has a $1\frac{1}{2}$ tone rating, a 160-inch wheelbase, and is of the school-bus type, which has much softer springs than the usual truck chassis. Overall dimensions are: length 262 inches,



height 109 inches, and width 89 inches. This permits an inside height of 72 inches, an inside width of 84 inches, and a useful length of about 168 inches. The gross weight of the complete unit without the equipment is 9500 pounds and the maximum safe load is approximately 4000 pounds.

In Figure 1 we see the mobile unit as it might be used for picking up a television broadcast at an airport. Note that the rear of the unit is designed for use as a small control room, one camera and the microwave transmitter have been placed on the roof and one camera is located on the ground. Access to the roof is provided by a hatch and ladder located inside the unit. In Figure 6 we see the field equipment as it is mounted in the rear part of the vehicle. The television control units, which require routine observation and adjustment during a broadcast, are located in a very convenient position for the control operators. Those units, such as power supplies, which normally require no adjustment are located beneath the console. All units are placed on shock mounts in order to minimize vibration effects in transporting equipment from one location to another. Note that the relay transmitter control is mounted on a shelf above the other equipment, where its operation can easily be checked



FIG. 7. (left) *Rear view of unit showing how cable reels can be pulled out to facilitate unreeling. Inner end of cable extends through hole in reel to receptacle on camera control units on the operating table just above.*

mind of providing the maximum convenience in setting up the equipment. Note that each reel has a hole through which the inner-end of the camera cable, including the plug connection, can be placed. In normal operation approximately 4 feet of cable is pulled through this opening and placed around the hub in such a way that the reel can be rotated without damaging the cable connector. The remainder of the camera cable is then wound on the reel which is able to accommodate as much as 200 feet. In setting up for a broadcast it is, therefore, only necessary to unreel a sufficient length of cable to connect between the camera and the mobile unit. When this is done the inner-end of the camera cable can then be removed from its location around the hub and connected to the desired camera

at any time. The windows at the back and sides provide the operators with an excellent view of the surroundings whenever the mobile unit can be located in a position where a view of the scene to be televised can be obtained. Curtains are provided for covering these windows in order to darken or partially darken the operating position. It may also be desirable to keep the curtains down when the mobile unit is located at a point where the scene to be televised is not visible. A draw curtain is located immediately in back of the three seats and can be used to exclude the light coming in from the front windows of the unit.

Figure 4 shows a plain view of the equipment arrangement in the vehicle. The major part of the space forward of the control position is devoted to storage facilities. In this space there are shock mounts upon which the cameras can be placed for transporting them between pickup locations. Cabinet space is also available for the tripods, for the relay transmitter and antenna, for additional reels of cable, intercommunication facilities and all the odds and ends that are needed for picking up a broadcast in the field. There are also several storage compartments on each side of the unit which can be used for storing such items as tools, ropes, short lengths of cable, etc. All the field equipment, as well as the relay equipment, has been described in previous articles appearing in *BROADCAST NEWS*. One new unit, which we have developed especially for use in the mobile unit, is the power control. In this unit we have voltage control and measuring devices so that adjustments can be made to accommodate a voltage input range from 90 volts to 230 volts. A maximum demand watt-meter has also been included in the unit so that a record of the power consumed for any broadcast can readily be obtained.

A close-up view of the rear of the unit is shown in Figure 7. In this view the position of all the units as well as the reels can easily be seen. The reel mountings are designed so that they can be pulled out from the normal position in such a way that reeling and unreeling can be easily and conveniently accomplished. The reels have been designed with a purpose in

control. In this way we avoid having large coils of camera cable, which are frequently in the way and are awkward to move at pickup locations. If it is necessary to move the equipment out of the mobile unit the reel can also be lifted from its mounting quite easily. Since aluminum castings have been used in the construction the overall weight of reel and cable has been kept down to about 100 pounds. After a sufficient length of cable has been unreeled to provide a connection to the camera and the inner end of the cable connected, the cable reel can be dropped back into position and the rear doors of the mobile unit closed. A rubber buffer at the bottom of the doors permits the cables to go underneath the doors without damage. During hot weather it will probably be desirable to keep the rear doors open, thereby providing a convenient method of ventilation. To supplement this the side windows at the rear can also be opened and the opening of the hatch in the roof can be used to provide additional cooling facilities.

Experience to date, with this mobile unit, has indicated that it fulfills the requirements to an exceptional degree. The writers wish to express appreciation to Mr. Pike of the styling department and Mr. Hafer of the Boyertown Body Co., who have contributed a great deal to the success of this unit. In addition they wish to thank their fellow workers at RCA for the cooperation, without which this project would not have been possible.

References

- ¹ "RCA's New High-Sensitivity Camera Revolutionizes Television Pickup Technique," *BROADCAST NEWS*, Vol. No. 42, Page 48.
- ² Bean, Norman S., "The TK-30A Camera With The Image Orthicon," *BROADCAST NEWS*, Vol. No. 44, Page 6.
- ³ Roe, John H., "Image Orthicon Field Equipment," *BROADCAST NEWS*, Vol. No. 45, Page 56.
- ⁴ Poch, W. J., and Taylor, J. P., "Microwave Equipment For Television Relay Service," *BROADCAST NEWS*, Vol. No. 44, Page 20.

TTR-1 and TRR-1 TELEVISION RELAY UNITS TESTED OVER LONG DISTANCE

Recently conducted tests have shown that standard RCA microwave television relay equipment (Type TTR-1 Transmitter and TRR-1 Receiver described in BROADCAST NEWS No. 44) may be used over much greater distances than was originally considered practical.

These experiments, which herald the expansion of television "on-the-spot" coverage, were conducted by the RCA Engineering Products Department over a period of several weeks. During this time, RCA engineers demonstrated for a number of station engineers the ease with which this equipment may be used to relay video signals 30 miles or more. Tests were also made to show

the quality of the microwave equipment, a monoscope camera was used to transmit a standard test pattern from the New Jersey site to Philadelphia and no degradation in picture quality could be observed.

The results of the experiment proved that the same type of RCA link equipment now used by most of the country's television stations to relay video pictures of news events, sports and the like, can be used to relay video signals for as much as 30 miles. With the use of six-foot reflector dishes, the link equipment could be used to transmit television programs for 40 miles. In past experiments with RCA microwave relay equipment, video signals have been transmitted through two sets of equipment in series, with no visible loss of picture quality. At these high frequencies, the wavelength is less than 5 centimeters, so that antennas which have very high gain, but relatively small size, are used. This high gain provides two big advantages. First, it provides a relatively high "equivalent power" with a very low transmitter power. For example: by using the four-foot parabola and a transmitter of 100 milliwatts, an equivalent power of 500 watts is obtained. A second and equally important advantage is that transmitted power is concentrated in a very narrow beam. The receiver, which uses a similar antenna, has a very narrow angle of pickup. When the two antennas are lined up on each other, an exceedingly selective path is provided. This has the effect of eliminating all extraneous reflections, whether from fixed or moving objects.



FIG. 1. Receiver antenna mounted on top of 18-story Bank Building in downtown Philadelphia. S. H. Barbour (kneeling) is explaining operation to George E. Hogerty (left), engineering manager of Westinghouse Radio Stations, and W. H. Hauser, Chief Engineer of WBZ.

the effectiveness of picking up video signals in the outer fringe of a station's coverage area, and transmitting them to a distant point by microwave radio relay link equipment for rebroadcast.

For the purpose of these tests a standard TTR-1 Relay Transmitter with a four-foot parabolic reflector was installed on a hundred-foot tower located at Bordentown, N. J., about 27 miles from Philadelphia. A conventional half-wave antenna was used to pickup television programs coming in from New York City at standard television frequencies. The programs received were then fed to the microwave relay transmitter and sent in a highly-directional beam to a receiver setup on top of the Market Street National Bank in Philadelphia.

The television pictures received in Philadelphia were judged as good as those picked up in Bordentown, but to further test

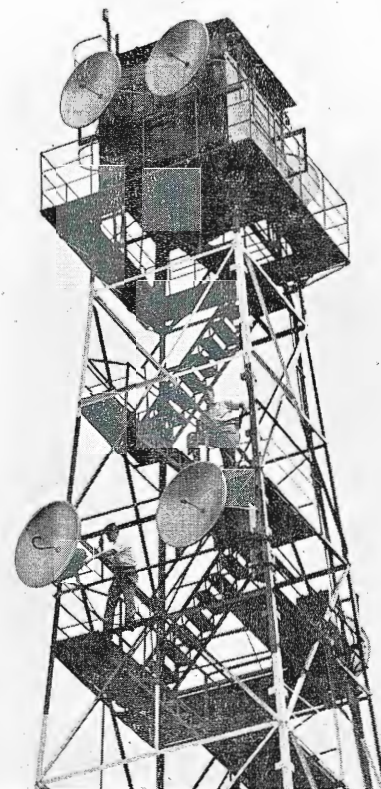

FIG. 2. Transmitter antenna (the parabola at lower left) mounted on Western Union Relay System tower at Bordentown, N. J., about 27 airline miles from the receiving antenna.



(LEFT) The visiting broadcast engineers get a few pointers about the 16mm television projector from Frank M. Folsom, Executive Vice President in Charge of the RCA Victor Division. Shown left to right are: W. H. Hauser, WBZ, Boston; George S. Johnson, KOB, Albuquerque; J. Duncan, WLW, Cincinnati; Mr. Folsom; G. O. Milne, ABC, New York; Merrill A. Trainer, RCA; Dan Hunter, WMAL, Washington, D. C.; E. J. Meehan, Jr., RCA; Paul Wittig, CBS, New York; John M. Sherman, WTCN, Minneapolis; and Cliff Denton, of the New York Daily News.

TOP ENGINEERS ATTEND TELEVISION COURSE

by ERWIN B. MAY, Publicity Dept., RCA Victor Division

Thirty-three of the nation's top-ranking broadcast engineers, representing the major radio networks and leading independent stations, which are operating or planning television service, assembled in Camden, N. J., the week of May 19th, to attend the first television engineering training program ever conducted in the industry.

The week-long television clinic, sponsored by the RCA Engineering Products Department, was a comprehensive training program which included technical discussions, demonstrations, and practical experience with RCA television broadcasting and studio equipment.

Merrill A. Trainer, Manager of RCA Television Equipment Sales, who was host to the visiting broadcasters, stated that the primary purpose of calling the group together was, "To give the participants a comprehensive understanding of the theory, operation, and maintenance of RCA equipment, in order to furnish commercial television broadcasting at the high service standards which have been established for radio broadcasting."

The television clinic was conducted at an engineering level with the staff of in-

structors composed of the same television engineers who designed and developed the RCA equipment.

Lecture classes employing the latest techniques of audio-visual instruction, including motion pictures and slides, were supplemented by "on-the-job-training" with television production units identical to those which the broadcasters will soon be using in their own stations.

Typical of the instructors was Norman Bean, who adapted the idea of quick-change rotatable lens turret for use on the Image Orthicon Camera. Mr. Bean gave a slide illustrated lecture on the Image Orthicon Camera including a discussion of what and what not to do in the operation and maintenance and trouble-shooting of the camera and circuits.

A specially-written 200-page textbook containing all the material covered by the technical clinic was prepared in a leather-bound edition for each of the attending broadcasters, for later use as a reference guide.

Included in the week's schedule were trips to several sections of the RCA Victor Plant in Camden, and to the RCA Laboratories, at Princeton, N. J. In Cam-

den, the visitors saw RCA's new 5-kilowatt television transmitter in production, and they had a chance to gain practical experience in transmitter tuning, operation, and maintenance. A visit to the world's largest television receiver assembly line enabled the engineers to witness the mass production and testing of home receivers.

One of the broadcasters, after seeing the vast stream of television receivers moving down the assembly line toward completion, and being told that they were being shipped immediately to distributors, remarked, "Here is the strongest argument I have yet seen for forging ahead with television plans. Too bad the advertisers can't get to see this."

At the RCA Laboratories, the broadcasters heard a technical discussion on the Kinescope, Iconoscope, and other television picture reproduction tubes, by Dr. Albert Rose, co-inventor of the Image Orthicon pickup tube. Dr. P. T. Smith, who developed the revolutionary new 8D21 tube, discussed the research aspects of this high frequency duo-tetrode power tube, which is used in the audio and video power sections of the 5-kilowatt, TT-5A, television transmitter.

(RIGHT UPPER) Television receivers are inspected by a group of engineers while on tour of the television receiver assembly line. Merrill A. Trainer, Manager of Television Equipment Sales, is pointing out the deflection yoke used in the RCA home receiver. Shown from left to right are: H. L. Bergman, WBEN; Cliff Denton, New York Daily News; J. R. Harter, WMAL; L. H. Gilbert, WNBF; F. W. Harvey, WMAL; M. A. Trainer; Dan Hunter, WMAL; L. R. Tower, MBS; W. M. Stringfellow, WSPD; and R. A. Fox, WGAR.



(RIGHT CENTER) Norman Bean, RCA engineer, discusses the RCA Image Orthicon Television camera, while Glen Boundy of the Fort Industry Company peeks through ring sight finder. Standing left to right are: Mr. Bean, C. B. Lau, WMAR (behind Bean); W. H. Hauser, WBZ; O. W. Towner, WHAS; P. A. Goetz, CBS, New York; Paul Wittlig, also of CBS, New York; W. M. Stringfellow, WSPD; G. S. Johnson, KOB; and J. H. Keachie, RCA.



(RIGHT LOWER) This is a candid shot of a group of broadcasters observing the screen of a master monitor while B. L. Patton (extreme right), RCA engineer, discusses its operation. Left to right are: J. R. Harter, WMAL; F. W. Harvey, also of WMAL; Wm. Clancy, WTIC; John Roe, RCA, Camden; Sidney Stadig, WBZ, who is holding specially-prepared text of RCA equipment. (It's interesting to note how serious the men were in absorbing as much technical information as possible at an accelerated pace.)

Broadcasters who attended the conference were: Howard L. Bergmann, WBEN, Buffalo, N. Y.; J. L. Middlebrooks, G. O. Milne, Frank Marks, American Broadcasting Company, N. Y.; Paul Wittlig, Philip A. Goetz, Orville J. Sather, and John G. Wilner, Columbia Broadcasting Company, N. Y.; Lewis R. Tower, Mutual Broadcasting Company; Cliff Denton, N. Y.; Daily News, N. Y.; Lester H. Gilbert, WNBF, Binghamton, N. Y.; Frank W. Harvey, Dan Hunter, and J. Robert Harter, WMAL, Washington, D. C.; A. E. Evans, ABC, San Francisco, Cal.; T. B. Palmer, ABC, Hollywood, Cal.; Robin D. Compton, WPEN, Phila.; Charles W. Burtis, WPEN, Phila.; Sidney Stadig, WBZ, Boston; W. H. Hauser, WBZ, Boston; E. C. Horstman, ABC, Chicago; George S. Johnson, KOB, Albuquerque, N. M.; Robert A. Fox, WGAR, Cleveland; William Clancy, WTIC, Hartford; John M. Sherman, WTCN, Minneapolis; Orrin W. Towner, WHAS, Louisville; J. Duncan, WLW, Cincinnati; C. B. Lau, WMAR, Baltimore; L. L. Caudle, Jr., WSOC, Charlotte, N. C.; Wilfred Wood, WMBC, Richmond, Va.; Glenn Boundy, The Fort Industry Co., Detroit; Wm. M. Stringfellow, WSPD, Toledo; John Fricker, KSTP, Minneapolis, Minn.



A HIGH SCHOOL GOES FM

by
JOHN W. STAHL
Chief Engineer, WSHS

The first educational radio station in the new FM band went on the air when WSHS, owned and operated by Sewanhaka High School, Floral Park, New York, began test programs on February 18, 1947, using an RCA BTF-250A transmitter.

Not only is WSHS a pioneer in the high school broadcasting field, but it has the additional distinction of having been assembled almost entirely by students and will someday be completely operated as a student project.

The value of radio to schools has been recognized by educators for many years, both from the programmatic and the technical points of view. But the magnitude and complexity of the task of installing and operating a radio station have undoubtedly discouraged many administrators. While setting up a broadcast transmitter, with all of its necessary auxiliary studio and control equipment, is a huge undertaking for a high school. It is hoped that the following description of the construction of WSHS will make other school authorities take heart so that

thousands of other high school students can have the great advantages offered to them by constructing and operating school radio stations.

The idea of building this station was conceived during the recent war when, however, it was impossible to obtain broadcasting equipment. But a cottage, located on land purchased by the school a few years earlier, was converted into two studios, an audition room, and a control room. The studios were equipped with several homemade amplifiers, which made it possible for students to learn radio techniques by "producing" simulated broadcasts. All alterations made in the building were accomplished with the background idea of installing a transmitter as soon as one could be obtained.

With the amplifier-equipped studios as a start, the school began radio station planning in earnest. The next step to most broadcasters would be to hire a consulting radio engineer. Schools as a rule usually cannot afford to do this. An effective

FIG. 1. (left) *Equipment at WSHS was assembled almost entirely by students. This illustration shows one of the students mounting the FM exciter in the RCA BTF-250A Transmitter.*

FIG. 2. (below) *Here two Sewanhaka students are working on the single-bay Super Turnstile, which was built entirely by students in the school's machine shop.*

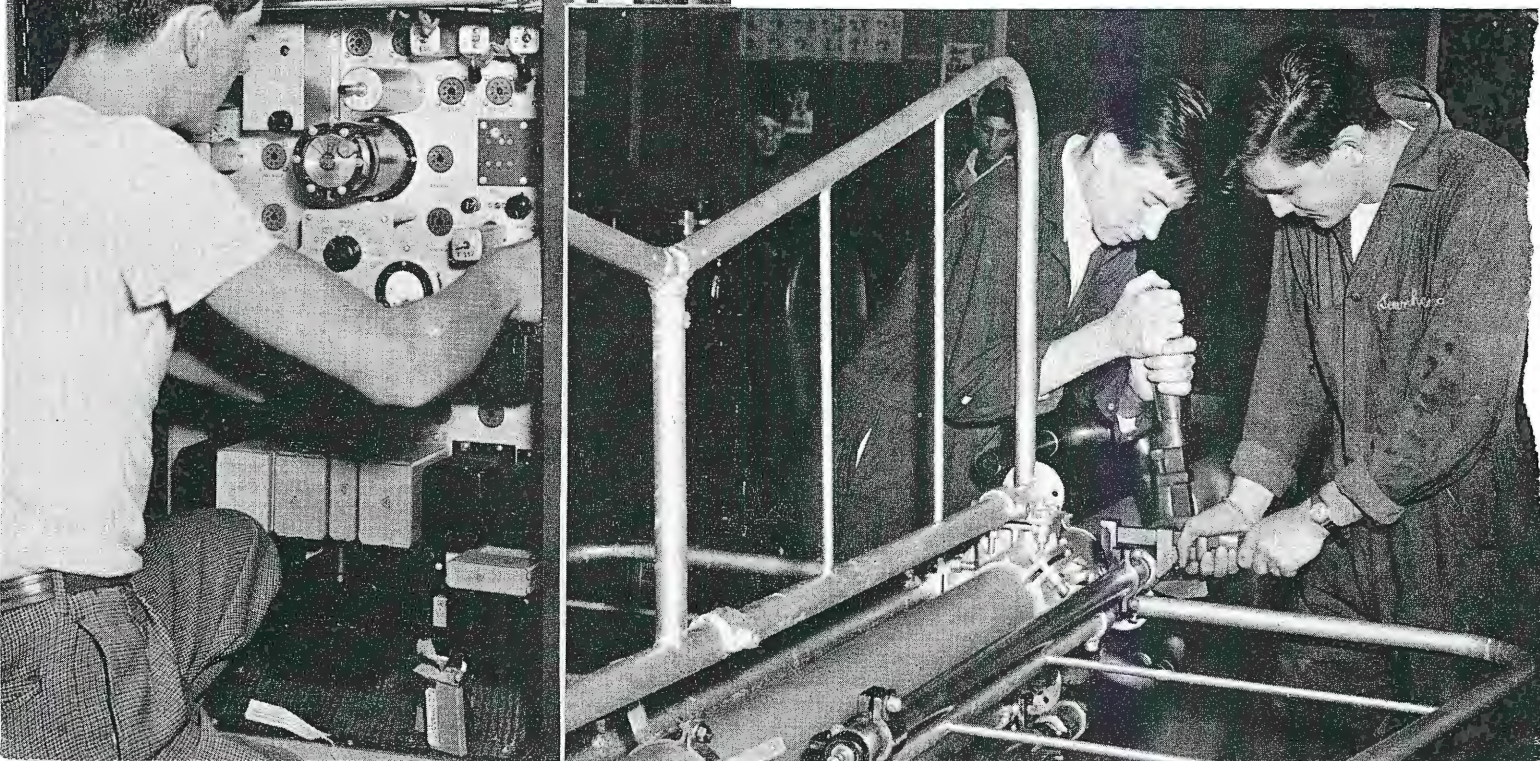
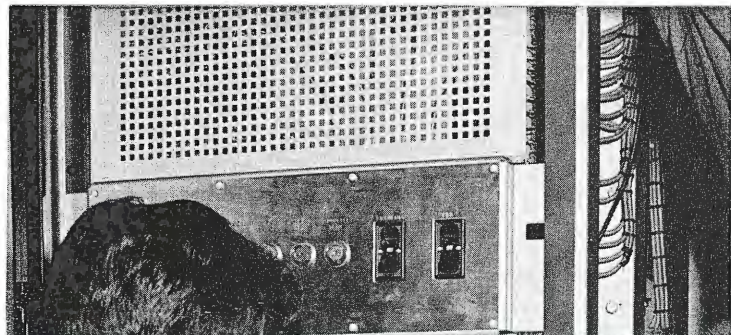

solution was found for this problem by simply asking several radio and community-minded citizens for advice. This practice, often successfully employed in similar projects at Sewanhaka, would probably raise a great deal of community enthusiasm wherever tried. A radio advisory committee, representing a wide variety of professional interests, was formed, including: Mr. Dutton Stebbins, American Telephone and Telegraph Company; Colonel Myron Doucette, now with A. Schraeder and Sons; Mr. Bruce Campbell, deceased, formerly with the New York Telephone Company; Mr. George M. Nixon, engineer, National Broadcasting Company; Mr. Peter Testan, chief engineer WBYN; Mr. Robert W. Schoppe, radio engineer; and Mr. W. LeRoy Hillman, Sperry Gyroscope Co. Members of the school faculty who worked with the committee included Dr. A. T. Stanforth, supervising principal; Dr. Hugh Flaherty, director of the vocational-technical department; Mr. Worthington Gregory, English department, and the writer.¹ RCA, when contacted about its plans for postwar FM transmitters, sent Mr. Charles Kleinman to committee meetings to aid in planning the station.

The first major problem the committee faced was to decide on the area the station should cover, together with the transmitter power required to do the job. The primary service area of this "community-educational" station consists of the towns of Floral Park, Bellerose, New Hyde Park, Garden City Park, Stewart Manor, Franklin Square, and Elmont, which support the Central High School district known as Sewanhaka High School. Calculations revealed that a 250-watt transmitter using a standard, one-bay RCA turnstile antenna, 90 feet above the ground, would give about 1000 microvolts per meter for the entire school district. However, a topographical map of the area surrounding the station for a radius of fifteen miles revealed a 90-foot ridge about two miles north of the antenna location. In order to serve communities located beyond the ridge along the north shore of Long Island, it was decided to mount the antenna 100 feet above the ground.

¹ Others who assisted are: Mr. Kenneth Place, building superintendent, S. H. S.; Mr. Charles Weckerle, school district engineer; Mr. Wesley Simpson.

The committee, having determined the size of the transmitter, then contemplated the possibility of having students build the unit. In view of the fact that very few FM transmitters for the new 88 to 108 megacycle band had been perfected at that time, it was considered impractical to attempt the job in the high school shops and laboratories. The antenna, although a big job for high school students, could be constructed in the school's machine shops. Hence, RCA agreed to furnish detail prints of its superturndial FM antenna when the order for the BTF-250A transmitter was placed.

The Federal Communications Commission issued a construction permit for station WSHS on June 18, 1946. From this point on, the students in the vocational-technical department took over the actual building of the station with all the great energy and interest that only teen-agers can display.

The antenna, which is supported by a 100-foot steel tower obtained from U. S. Army surplus, was begun first so that the steel company that erected the tower could also place the antenna on the tower before winter weather set in. Castings for the antenna could not be made in the school shops because there were no facilities for obtaining the high temperature necessary for melting manganese bronze. But the wooden patterns for the castings, however, were made by the wood shop students before the 1946 summer vacation. The castings, made by an outside foundry during the summer, were machined to close tolerances by the machine shop students. The unit was assembled in the shop, as seen in Figure 2, and was hoisted onto the tower in November, 1946. See Figures 4, 5 and 6.

While the machine shop students were building the antenna, other students in the senior class in technical electricity were installing, under the supervision of the writer, the necessary control and power wiring in the building where the transmitter is installed. Figure 7 shows the layout of the studios, control room, and transmitter room. Shielded, twisted-pair audio lines for microphones and loud speakers are installed in conduits in the walls and on the cellar ceiling of the frame building. The power supply for the RCA 76-B2 audio control console is installed in the basement almost directly under the control

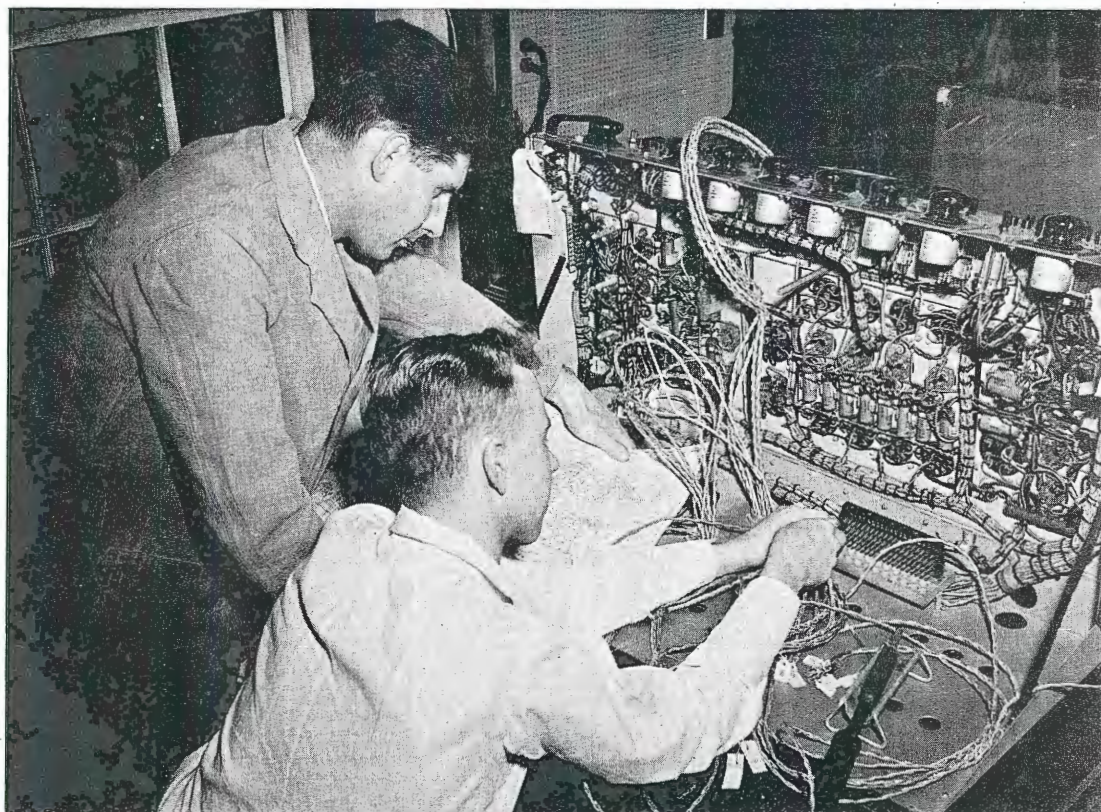

FIG. 3. (right) In this view one of the students is making wiring connections to the RCA 76-B Console while an instructor supervises the operation.

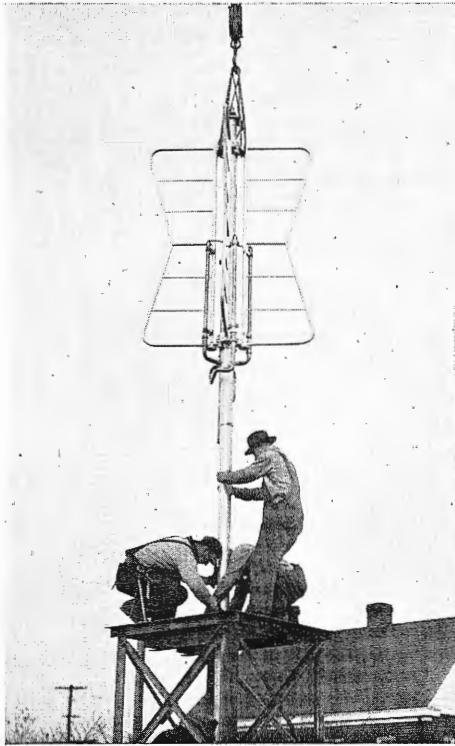

FIG. 4. *Installing the turnstile element on the top section of the tower.*

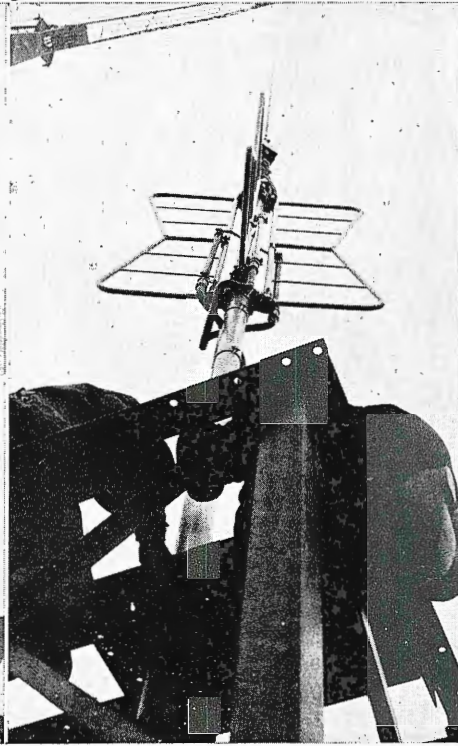

FIG. 5. *This work was done on the ground before lifting the top section into place.*

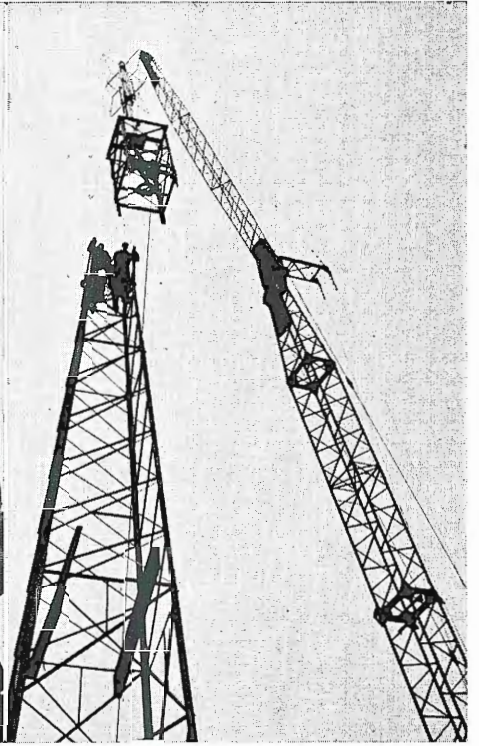

FIG. 6. *This shows the turnstile and top section of the 100-foot tower being lifted into place.*

room. Hence, the filament and plate supply lines are kept short while the power supply unit is in a readily accessible place for servicing. A terminal box for all consolette lines is installed under the table supporting the consolette unit. Relays for the one-the-air signs are also located under the consolette table.

As there is no room in the buildings for an announcing-transcription booth, turntables had to be located on either side of the consolette, as shown in Figure 8. The talk-back microphone in the control room is connected so that it also can be used for on-the-air announcing. This arrangement has the added advantage of permitting the consolette operator to play records, as well as monitor programs from the studios. Booster amplifiers for the transcription turntables, built by students in the school's electrical laboratory, are located in the supporting cabinet of each turntable unit.

Naturally the studios must have some sound-proofing. Here again the advisory committee was consulted. It was decided to use sound-proofing tile on the ceilings. The studio walls are not completely covered with sound-proof material because it was considered unnecessary, besides, the studios have outside windows, the removal of which would have required air conditioning the rooms. Sound-proofing sections were installed on the studio walls. To date, actual broadcasts from these studios indicate that the sound-proofing is adequate.

A $\frac{7}{8}$ " air-filled, coaxial transmission line is used in station WSHS to feed the transmitter output to the antenna. In view of the low power to be transmitted, together with the fact that the losses in 140 feet of the $\frac{7}{8}$ " line are so small, it was not worth while to spend the additional money for a $1\frac{5}{8}$ " line. A detailed drawing of the line, for the supplier's use, was made by a technical electrical student from the blue prints of the antenna

tower and a catalogue of flanged transmission line fittings. The air pressure, of about 15 pounds, is obtained from a hand-operated pump. Although several gallons of soap water were used to locate air leaks, once the leaks were repaired the air pressure remained constant, except for changes due to temperature, indicating that an expensive automatic power-driven pump is unnecessary for a radio station of this type.

The transmitter, heart of the broadcasting station, was delivered in the usual fashion in nine or ten packing cases. The assembly of the unit, generally done under the supervision of a representative of the manufacturer, was accomplished by the electrical students of Sewanhaka High School, directed by the writer. While this is not a difficult feat for professional engineers to perform, it was extremely gratifying to see seventeen year old students assemble the units from the manufacturer's blue prints. As so often happens, during the shipment of equipment, marking tags were displaced from wires. The meter panel of the transmitter was no exception to this common trouble. The students assembling the unit, however, lost little time in testing for the proper connections to the meters.

The alignment of the exciter unit of the transmitter was no small problem. Although the instructions for this procedure are furnished by RCA, some of the "trade tricks" used in the adjustment of the unit in this transmitter are included here in the hope that they will be helpful to others. The method of obtaining frequency control in this type of unit is quite common knowledge among radio people. To refresh the reader's memory a block diagram of the system used is given in Figure 9. The frequency of the master oscillator, modulated by the audio signal through the reactance tubes is reduced to a relatively low frequency by the dividers, and fed into the motor control tubes. The output of the crystal oscillator, reduced by other dividers

FIG. 7. Floor plan layout of the studios, control room, and transmitter room. Equipment items are as follows:

- A. Transmitter
- B. Console
- C. Monitor
- D. Mic. outlets
- E. Cue speakers
- F. On-air lights
- G. On-air lights
- H. Turntables.

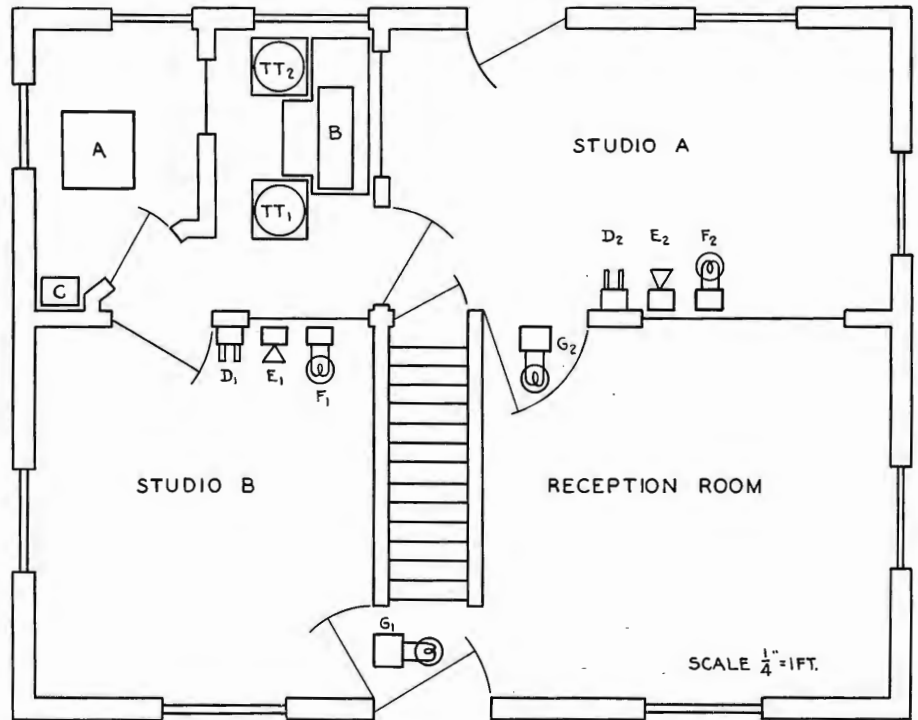

to the same frequency as that from the master oscillator, is fed into the motor control tubes through a phase shifting network, providing a two-phase supply for the motor. If the master oscillator frequency drifts, it causes a phase shift of one of the two phases supplied to the motor, causing the motor to turn, which corrects the master oscillator frequency by adjusting the capacitor attached to the motor. An oscilloscope is provided in the unit to aid in the adjusting procedure. The objective in adjusting the master oscillator is to have its output frequency set so that after going through the dividers it will arrive at the motor tubes at the same frequency as the one coming from the crystal oscillator. A good quality, accurately calibrated communications receiver having a beat-frequency oscillator is recommended by RCA for adjusting the master oscillator. The only receiver available at WSHS was not accurately calibrated, but by using the crystal oscillator in the exciter unit as a frequency standard the following system was devised to tune the receiver to the desired frequency.

The receiver dial was adjusted, as carefully as possible, to the frequency desired for the exciter master oscillator.

FIG. 8. Turntables are located in the control room as shown here, since there was no room for a separate announce booth. Microphone shown can be used for eüher talkback, or announcing.



The antenna post of the receiver was then connected through a short coaxial lead, containing a small coupling capacitor, to the plate of the crystal oscillator tube. With the master oscillator tube removed to prevent its output from affecting the calibration, the receiver dial was tuned for maximum response from the crystal oscillator. Due to image responses, characteristic of super-heterodyne receivers, there were several points on the dial where the signal was heard. Although the receiver was operating on the 240th harmonic of the crystal, the loud speaker volume at the correct dial setting was sufficient to prevent error due to image

response. After the receiver dial was set, the master oscillator tank was tuned until zero beat was heard in the receiver. The receiver had to be moved quickly from the crystal oscillator to the master oscillator to avoid error due to frequency drift of the local oscillator in the receiver. The dividers in the exciter were then adjusted using the oscilloscope tube, provided in the transmitter, as an indicator. If the master oscillator is off frequency slightly, the proper direction for turning its adjustment may be obtained readily by noting in which direction the crystal oscillator divider adjustment must be turned in order to produce a circle on the oscilloscope tube. This last step is included in the RCA instruction book; however, unless the master oscillator frequency is nearly correct, adjustment of the crystal oscillator divider will not produce the desired circle.

Another difficulty encountered in this exciter unit was located in the alarm switch actuated by the frequency control motor. If this switch, which operates only when the automatic frequency control fails, drags on the motor shaft at all positions of the shaft the motor will hunt, making it impossible to maintain the proper oscilloscope pattern. The remedy is, obviously, to adjust the switch position.

Although nothing has been said so far concerning frequency and modulation monitors, it is well known that units of this type are required by F.C.C. at all broadcasting transmitters. WSHS is operating at present without the monitors, by special F.C.C. permission, pending delivery of the equipment in the near future. These monitoring units are to be installed in the transmitter room as shown in Figure 7. Frequency checks are obtained through RCA's frequency monitoring service located at Riverhead, L. I. Modulation measurement is not so simple. But the proper audio level to give the desired modulation was determined by using the phenomenon of a frequency modulated wave, which is: for a certain audio frequency, at a given audio level, the center or carrier frequency disappears, leaving just the upper and lower sidebands. The communications receiver, shown in Figure 10, is adjusted to the carrier frequency of the station or one of its multipliers. The audio oscillator is adjusted until the vacuum tube voltmeter across the output of the receiver reads zero or dips toward zero.

$$\text{Then } \alpha F = F_A M 2.4$$

Where αF = frequency swing in kilocycles.

F_A = frequency of audio oscillator in kilocycles

M = multiplying factor of transmitter doublers

2.4 = modulation index

Obviously, the reading of VU meter on the audio control console at the time the V.T.V.M. across the receiver reads zero will be a measure of the modulation at that instant. By adjustment of the output of the console and repetition of the procedure outlined above, the proper audio level to give 100% modulation can be determined.

A study of the studio layout, shown in Figure 7, will reveal that the size of the rooms will limit programs to those requiring relatively few persons. This shortcoming would obviously waste a great deal of the potential program material available. The school band, string orchestra, and glee club, each consisting of twelve or more people, could not broadcast from the present studios. To overcome this difficulty, it is planned to install remote lines between the school building and the radio house. Six pairs of remote lines are considered sufficient, between the transmitter control room in the radio house and a central point in the main building, to handle all program and cueing circuits. Permanent lines are to be installed in the school from the music room, auditorium, and gymnasium. The facilities for operating from remote points are, of course, provided in the RCA 76B-2 control console located in the station control room. Three portable amplifiers for remote pickup duty are being constructed by students in the electrical laboratory of the school. Each amplifier is to be equipped with three microphone input circuits, VU meter, and cueing circuits. The units are designed to be flat to 15,000 cycles to meet the standards of good engineering as set forth by F.C.C.

Present F.C.C. regulations do not require educational FM stations to perform field strength measurements. It is planned, nevertheless, to conduct the usual standard station tests on WSHS. The results of the tests will certainly be of great interest to all concerned with school-operated radio stations. The tests will be conducted by students in order to have them obtain all the practical experience possible from the school station.

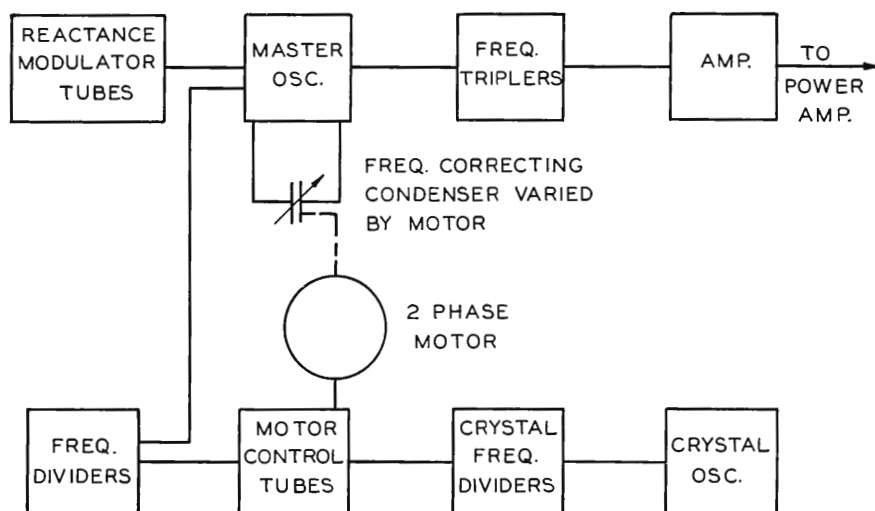

FIG. 9. This is a block diagram of the exciter unit in the BTF-250A Transmitter at WSHS. Operation and adjustment are described in the text.

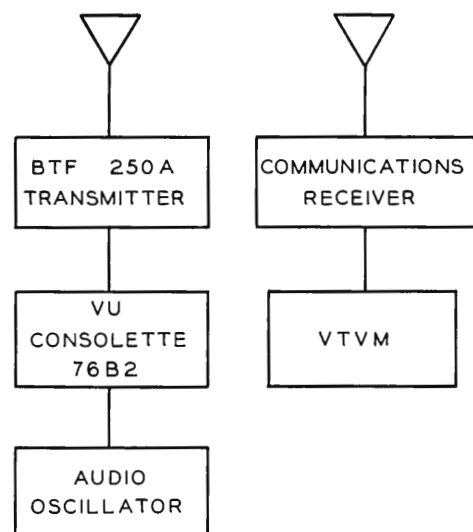

FIG. 10. Diagram illustrating the use of a receiver and audio oscillator to check modulation.

CAMERA PLACEMENT AND SWITCHING *for* BASEBALL BROADCASTING

by JOHN P. TAYLOR

Engineering Products Department

INTRODUCTION

In this article, and the picture story which follows, we have collected just about all the information available on camera placement for baseball pickups. We have not done this with a view to helping the presently operating stations—for their operators certainly know more about the subject than we do. Moreover, by the time this appears in print, the 1947 season will be nearly over.

Our object, rather, was to collect this material for the benefit of the considerable number of new stations which will be on-the-air by the time another season rolls around. Many, if not all of these new stations, will be planning to telecast local baseball games. Most of their personnel will be relatively inexperienced. And, unfortunately, some of their planning (such as proper provision for camera setup) will need to be done before the season opens. In these circumstances it should be of considerable value to know what others have done when faced with the same problem.

The first five pages of this article constitute a general discussion of the problem of positioning and switching cameras. A

table on Page 58 shows at a glance what has been done this year. The next four pages are actual photographs of the camera setups used by seven of the nine stations telecasting baseball during 1947. The next two pages show, by pictures from the monitor screen, how the field of view varies in size with the various available lenses. Following this are two pages illustrating, in similar manner, several standard camera switching sequences.

POPULARITY OF BASEBALL

Baseball telecasting is, today, one of the important segments of television programming. During the last few months nine of the eleven active television stations have been programming several games a week. Two of these stations, WPTZ and KSD-TV, telecast both National and American League games, so that they are on almost every day. Schedules are not limited to daytime games since, with Image Orthicon cameras, night games are as easy as daylight pickups. (In fact, the night pickups are sometimes better due to more even lighting and lack of sharp shadows, such as occur on bright sunny days.)

A cursory examination of the schedules of all eleven active stations indicates that during June and July close to fifty per



FIG. 1 (left) This is the "standard" shot of baseball television—ordinarily used during the full time the batter faces the pitcher. Made with a 135MM lens in a camera about 65 feet away it gives a field about 15 feet wide at the plate, with depth sufficient to show everything from umpire to second base. In this NBC photo they are "walking" the batter.

TABLE NO. I
TYPE AND LOCATION OF CAMERAS IN USE DURING 1947

<u>Station</u>	<u>Games of</u>	<u>Location</u>	<u>No. of</u> <u>Cameras</u>	<u>Type of</u> <u>Cameras</u>	<u>Location of Cameras</u>
KSD-TV St. Louis	Cardinals & Browns	Sportsmen's Park	2	RCA TK-30's	Both on 1st base line
KTLA Los Angeles	Pacific Coast League	Los Angeles, Hollywood	2	RCA TK-30's	One behind plate One on 1st base line
WABD New York	Yankees	Yankee Stadium	3	Dumont	One behind plate Two along 1st base line
WBKB Chicago	Cubs	Wrigley Field	2	RCA TK-30's	Both on 3rd base line
WCBS New York	Dodgers	Ebbets Field	2	RCA TK-30's	Both behind plate
WNBT New York	Giants	Polo Grounds	3	RCA TK-30's	One behind plate Two on 1st base line
WNBW Washington					
WPTZ Philadelphia	Phillies & Athletics	Shibe Park	2	RCA TK-30's	One high behind plate One low behind plate
WRGB Schenectady					
WTTG Washington	Senator	Griffith Stadium	2	Dumont	
WWDT Detroit	Tigers	Briggs Stadium	2	RCA TK-30's	Both behind plate

cent of all television time on the air consisted of baseball. Several reasons for this are apparent. First, the great popularity of sports telecasts (practically all surveys show them first in overall popularity). Second, the relatively low cost of such programs compared to live studio productions. And, third, the fact that field equipment has been available in quantity, whereas standard studio equipment of postwar design is only just now appearing.

It is obvious that time will change the present balance of television program content. However, baseball is of transcendent interest to a large segment of the listening audience. Moreover, it comes at such times (afternoons and summertime) that it does not compete with the premier time (evenings, winter) that is likely to be used for deluxe studio programs. Thus, while the per cent of total time given to baseball will certainly decline from the present peak, it is likely that the time in hours devoted to this kind of program will remain substantially the same.

TYPE OF CAMERAS USED

All of the nine stations now telecasting baseball games use Image Orthicon cameras. Image Orthicons have several advantages which make their use for this purpose almost mandatory. First, their sensitivity makes it possible to obtain good pickups even on cloudy days (experience indicates that satisfactory pictures can be telecast even when a light rain is falling). Second, the range of sensitivity is such that players in the shadow of the grandstand can be seen almost as well as those in the bright sun (and "crowd" shots in the stands can be alternated with shots of the playing field). And, third, cameras with Image Orthicons can be "stopped down" further, thus giving a greater depth of focus. This is important in getting a picture such as that shown in Figure 1 (where the pitcher is almost twice as far from the camera as the catcher).

Seven of the nine "baseball" stations use RCA TK-30A Cameras (see Table I). This camera (BROADCAST NEWS, No. 44,

FIG. 2. (right) Three types of camera locations are used by the nine stations presently telecasting baseball games. They are illustrated in the three views at the right.

(a) Directly behind homeplate (or a few feet either side) as illustrated by this KTLA photo. Note camera in lower right corner.



(b) Along the 1st base line (preferably fairly high) as in this photo of NBC cameras at Yankee Stadium.



(c) Along the 3rd base line (also well up) as in this photo of NBC cameras at Ebbetts Field (during 1946).



Page 6) is a highly-developed unit which is based on the experience gained by RCA engineers in building several previous commercial models (and some 4000 television cameras for the services during the war). Its most important feature, so far as baseball pickups are concerned, is the four-position lens turret which makes it possible to change lens sizes in a matter of seconds. Baseball televising requires wide-angle lenses for pickup of the whole field, medium-angle lenses for "crowd" shots, and narrow-angle lenses for player closeups. Since the latter vary from the batter, some 50 feet from the camera, to the outfielders, who may be 350 to 400 feet away, several narrow-angle lenses are required. Ordinarily at least five different lens sizes are used. In a sequence involving outfield and infield plays a minimum of three sizes is required. Occasionally, four sizes are used on a single sequence. Thus, unless a multiplicity of cameras is used, the turret lens is a necessity.

NUMBER OF CAMERAS

The minimum number of cameras for successful baseball televising is two. It is, of course, possible to telecast a game with

one camera, and the author recently watched a game done in this manner (the No. 2 camera had broken down). However, when one camera must cover all the action, it has to be "panned" from homeplate, to outfield, to infield (or from homeplate to short, to first, etc.) with a rapidity which has a tendency to make the viewer dizzy. Use of two cameras allows one to "anticipate" the play and thereby allow the director to make his widest movements by switching rather than panning. Moreover, as cameramen and director gain experience they can arrange their switching sequences in such a way that lens changes are made while the camera is off the air, thereby avoiding the blank moment which occurs when the lens turret is rotated while on the air.

Of course, the number of cameras used is related directly to the question of whether or not these cameras are provided with a means of quick-changing lenses (i.e., a lens turret). Thus, to obtain the same flexibility provided with two cameras of the turret type will almost certainly require three, and possibly four, cameras of the non-turret type. Table I indicates the num-

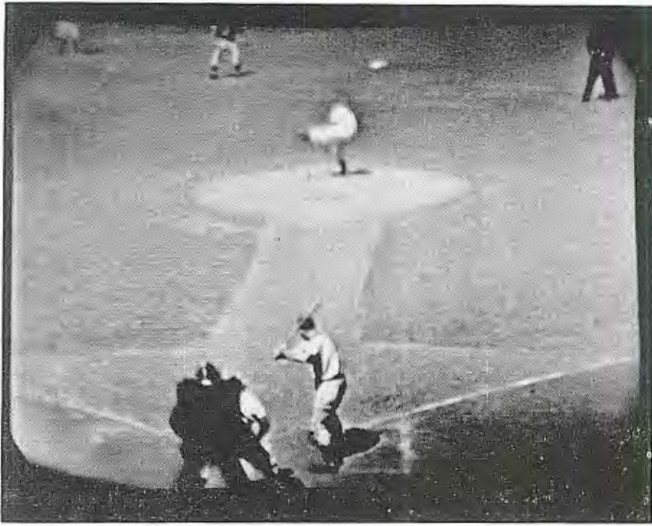

FIG. 3. "Standard" shot from a camera located behind homeplate.

bers of cameras being used (report as of August 1st) by the several stations. It will be noted that all but two of these stations are using two cameras. One of these stations uses non-turret type lenses, the other uses the third camera primarily as "protection" in case of failure of one of the others. In this latter respect, it is likely that availability has something to do with the fact that all the other stations usually use only two cameras. Certainly the provision of a "spare" would be worth considering on programs involving substantial advertising revenue.

CAMERA POSITIONS

Camera positions used by the present stations are shown in Table I. There are three general classifications: (1) behind homeplate, (2) along the 1st base line, and (3) along the 3rd base line. (These positions are illustrated in Figure 2.) This is also the order of preference, with the position behind the plate in the lead by a wide margin. In fact, most directors who do not have such a position indicate that they would use it if available. One reason is that with cameras on either baseline about half the batters (either lefthanded or righthanded) will have their backs to the camera. Another, and perhaps more important reason, is illustrated by Figure 3 and Figure 4. In Figure 3, where the camera is behind the plate, not only the umpire, catcher and batter are seen, but also the pitcher and, in fact, even the legs of the short stop. In Figure 4, where the camera is on the 1st baseline only the umpire, catcher and batter are visible. To get the pitcher into the latter (and this is considered very desirable during the time he is delivering the ball) it would be necessary to change to a wider angle lens and this would result in the figures being much smaller.

The scene shown in Figure 3, is the "standard" shot in baseball televising. Normally, the camera "sits" on this shot during the time the batter faces the pitcher—i.e., from the time he comes up until he hits or strikes out. This is a large percentage of the time (recently the author timed one game and found this shot was on screen approximately 53% of the total game time), and since it is also the shot of most interest, it seems reasonable to determine camera placement chiefly on the basis of the best



FIG. 4. "Standard" shot from a camera located along 1st base line.

results for this scene. It is this reasoning that leads to the choice of the "behind-homeplate" position.

CAMERA HEIGHT

The question of height and distance from the field must also, of course, be considered. Other things being equal, the closest position would be best. However, if both cameras are at one location then this must not be too low. For the "standard" shot (Figure 3) a position 15 to 20 feet high seems about right. However, this is too low for the best view of the outfield. If only one camera location is used, the preferable position is in the upper stands—which will be 30 to 70 feet high. A very nice solution to this is the one worked out by WPTZ, Philadelphia. (See illustration, page 62.) Their No. 1 camera is in a booth hung *below* the upper stands. The camera is about 20 feet off the ground and just a few feet off of the pitcher-catcher line. This camera is used for the "standard" shot, for infield closeups, and for "color" shots (arguments with the umpire, warmup pictures, etc.). WPTZ's No. 2 camera is located in the press booth up under the roof of the top stands. It is perhaps 60 feet above ground and directly over the No. 1 camera position. This high-up camera provides a beautiful shot of the outfield positions and is also very satisfactory for closeups at the bases.

LENS SIZES

An appreciation of what can be done with each of the several sizes of lenses is essential to good baseball pickups. When using TK-30A Cameras, the four-position lens turret makes it possible to have eight different lenses available in a standard two-camera setup. However, since some of the lens sizes may need to be duplicated, particularly if the cameras are at different locations, it is more usual to use either five or six different sizes. Practice varies with respect to which lenses shall be placed in each camera. Location, of course, is the governing factor. The 50MM lens is a must for opening shots of the whole field. The 90MM is used when it is desired to see most of the infield (i.e., when men are on base). The 135MM is ordinarily used for the "standard" shot. The 220MM and 330MM are used for infield closeups

TABLE NO. II
SIZE OF FIELD OF VIEW WITH VARIOUS SIZE LENSES

Lens Size		Field in Degrees	WIDTH OF FIELD IN FEET AT							
			HOMEPLATE		PITCHER		2ND BASE		OUTFIELD	
Inches	MM		Camera No. 1	Camera No. 2	Camera No. 1	Camera No. 2	Camera No. 1	Camera No. 2	Camera No. 1	Camera No. 2
2"	50	34°	28	46	62	78	98	104	196	200
3½"	90	19°	16	27	36	46	57	60	114	117
5"	135	13°	11	19	25	32	40	43	80	82
8½"	220	8°	7	11.5	15	19	25	26	49	50
13"	330	5°	4.5	7	9.5	12	15	16	30	31
17"	430	4°	3.5	5.7	8	9.7	12	13	25	25
25"	610	2.75°	2.5	4	5.3	6.7	8.5	9	17	17
Distance—camera to object			50'	82'	110'	140'	176'	185'	350'	358'

and "crowd shots". The 430MM is used for outfield closeups, scoreboard, etc. The 610MM is not used very much because the narrow angle makes it hard to center and unsatisfactory for panning. With these general applications in mind the director must equip his cameras according to their location and expected use. In some cases it may be desirable to have all six sizes at each camera position. While only four can be mounted, it will be possible to substitute the other two by hand, if a minute or two is allowed for the operation. It is not, however, good practice to do this too much as the threads may eventually be damaged (the 8½", 13", 17", and 25" lenses on the TK-30A Camera have bayonet-type mountings and hence can be easily and quickly interchanged).

Table II lists the standard lens sizes which are available and gives the width of the field, both in degrees and in feet at certain positions on the playing field. These field widths must be considered as approximate, since the individual camera adjustment may change somewhat the size of the scanned part of the mosaic. Thus a particular lens, when used with two cameras, may give slightly different field sizes. In Table II, the field width

is given for two different camera positions—one about 50 feet behind homeplate and 20 feet high, the other in the same relative position but 70 feet high. Note that this places the No. 2 camera much further from homeplate and hence gives a wider field of view for the same lens. There is also some difference at the pitcher's mound and second base. For outfield shots either camera gives the same field. In order to give the uninitiated a better idea of what these fields represent, we have shown on Pages 66 and 67 actual pictures taken from a monitor when several sizes of lenses were in use.

CAMERA SWITCHING

Generalizing on the subject of camera switching is dangerous, since every director has his own ideas and some are very obstinate about it. However, there are some common points. One of these, which seems very simple, but is not always thought of in pre-planning, is that each sequence should be handled so that the two cameras always alternate in their shots. Thus if the first shot of a batter coming up is a closeup on Camera No. 1, then Camera No. 2 must take the next shot (in this case usually a closeup

of the pitcher winding up) and the third shot (usually the "standard" shot of umpire, catcher, batter and pitcher) must be with Camera No. 1. This necessitates making sure that No. 1 has available the 135MM lens required for this shot. It's a small matter, but one in which a slip-up may be quite embarrassing.

Another generalization which can be made is that at times the play will be so fast that the cameras will be able to keep up only if the cameramen are sufficiently adept to "anticipate" the play. Realization that cameras cannot always wait for the director's instructions usually leads to the setting up of more or less standard sequences to meet certain typical situations. For instance, with a man on first, Camera No. 1 will start with the standard shot and usually is instructed to follow the ball. At the same time, Camera No. 2 has instructions to follow the base runner. Thus, if the play is to 2nd, the director switches to Camera No. 2 for a closeup. If the play is at 1st, he will ride along with No. 1. Either way he is covered without need of further instructions to his cameramen. The manner in which this works out is illustrated by the monitor picture sequences on Pages 68 and 69. These indicate the method used by WPTZ for three different situations. Other stations may use variations of these. However, in almost every instance they have set "patterns" laid out ahead of time (and proved satisfactory by experience) which they rely on so that all members of the staff will know approximately what shot is coming next and can anticipate the necessary moves.

CAMERA OPERATORS

The comments up to this point relate to the systems used in baseball telecasting. There's an old saying that "any system will work if you have the right men". This is a gross exaggeration, but it certainly is true that the best system won't work if you don't have the right men. And this is particularly true of television pickups of sports such as baseball. Efficient handling of cameras requires cameramen of intelligence and experience. In an area where television is new the novelty will cover up for poor operating for a short period. But the honeymoon is not long. By the time he's seen his fifth or sixth game, the average viewer has become critical as to camera handling (he may not realize that poor camera handling is the trouble, but he will sense the fact that fumbling is going on). The answer seems to be that cameramen should either be experienced, or should have a stiff training course. In addition, they must know baseball inside and out. The same goes for directors and announcers. The permanent baseball lookers-in (as contrasted to those who look for awhile for the novelty) will be baseball addicts. They want their baseball straight—and they want to see the centerfielder as he catches the ball, not several seconds afterward!

Acknowledgement

The editors wish to express their appreciation to Mr. Fred Kugel, publisher of TELEVISION magazine, for permission to use, herein, material from an article entitled "Batter Up", which appeared in the July, 1947, issue of TELEVISION. We are also indebted to Mr. Clarence Thoman, WPTZ Director of Field Events, for assistance in getting the pictures shown on Pages 66-69, and for much of the background information on which this article is based.



WPTZ, Philadelphia (A's and Phillies) uses two RCA TK-30A Cameras. Both are behind homeplate just a few feet to the right of the pitcher-batter line. No. 1 camera is in a cage hung from the upper deck (left, above). No. 2 camera in the press box some forty feet higher (right, above).

Four lenses are used on each camera. On No. 1, the 90MM (3") lens is used when there are men on base; the 330MM (13") close-up for crowd shots, batter coming in to plate, etc.; 50MM (2") for wide angle shots; the 135MM (5") for the "standard" shots. No. 2 camera uses the 430MM (17") close-up for a catch

in outfield, batter coming up to plate, crowd shots; the 220MM (8½") for a first base play, picking up the umpire, first baseman and runner; the 50MM (2") for wide-angle shot of field, and the 90MM (3") for the commercial which is handled at the field. This commercial consists of a score sheet about two feet wide by a foot high, showing runs, hits, and errors; the figures being written in as the viewer watches (see top righthand illustration, Page 67). At the conclusion of this commercial switch is made to No. 1 for a close-up of pitcher. Switching sequence which follows from there on is illustrated on Pages 68 and 69.

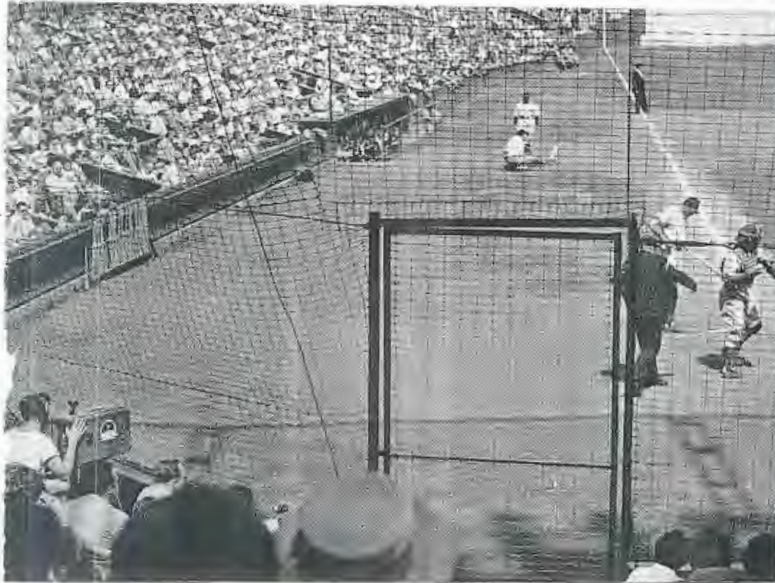

KTLA, Los Angeles (Coast League) uses two RCA TK-30A Cameras. The No. 1 camera is located directly behind homeplate in the lower stands (lower left corner of the lefthand view, above). The No. 2 camera is just off 1st base, also in the lower stands, but with sufficient height to follow action in the field. Excellent closeups on all bases are available from this camera position. No. 1 camera picks up the pitched ball as it comes over the plate, with No. 2 following the ball into the infield

or outfield, later switching to a closeup for the decisive action at 1st or 2nd base.

In order to orientate the viewer during a fast cut from long shot to closeup in the field, the announcer tells where each ball is hit and names the fielder who makes the play. Between innings, or during lulls in the games, the cameras follow players into the dugout, cover the crowds in the stands, show the new pitcher warming up, etc.



WNBT, New York (Giants) uses three RCA TK-30A Cameras. The No. 1 camera is behind homeplate in an upper mezzanine box. (In the view at left above, this camera is at the very right, just behind a white bar near the top of the illustration). The other two cameras are in another mezzanine box on the 1st base side of homeplate. (Behind the NBC banner in the lefthand view above.)

No. 1 camera. On No. 2, the 90MM, 135MM, 10" and 17" lens for closeups, outfield and new batters. The batter, pitcher, umpire, catcher, and man on second are picked up by the 90MM lens. When the bases are loaded, 50MM lens is used to give a big view of the park and to orientate the viewer.

While feeling is that it would be preferable to have the two behind home, cameras are not far enough apart to confuse the viewer. 50MM, 90MM, 100MM, and 135MM lenses are used on

About 17 men are in the NBC crew—including relief personnel, as cameramen are switched every few innings. Cameras are on permanent mounts, and coaxial cable, which had been installed previously, is used to relay the signal to WNBT.



WCBS-TV, New York (Dodgers) uses two RCA TK-30A Cameras, both of which are located in a press box booth behind homeplate but slightly to the left of the batter-pitcher line.

Basic coverage lens on No. 1 is the 135MM, which picks up the pitcher, catcher, batter, umpire. On No. 2 camera, 50MM, 135MM, 13" and 17" lenses are used. 50MM lens is used for opening and closing shots and once or twice during the game to get the whole diamond in, with the 135MM lens as protection if the need arises. The cameras are on permanent mounts.

135MM on No. 1 follows the ball in play, with a cut to the 17" closeup on No. 2 when the fielder is about to make the play. No. 1 has picked up the runner in the meantime—usually the man farther advanced on bases, and switch is made if the hit has been stretched to a double or triple. No. 2 goes to runner for closeup shot.

Crew of 8 technicians is used—3 cameramen (one for operating the camera in the control room to pick up the live commercial when given at the field); 2 control men, maintenance man, audio man and director.

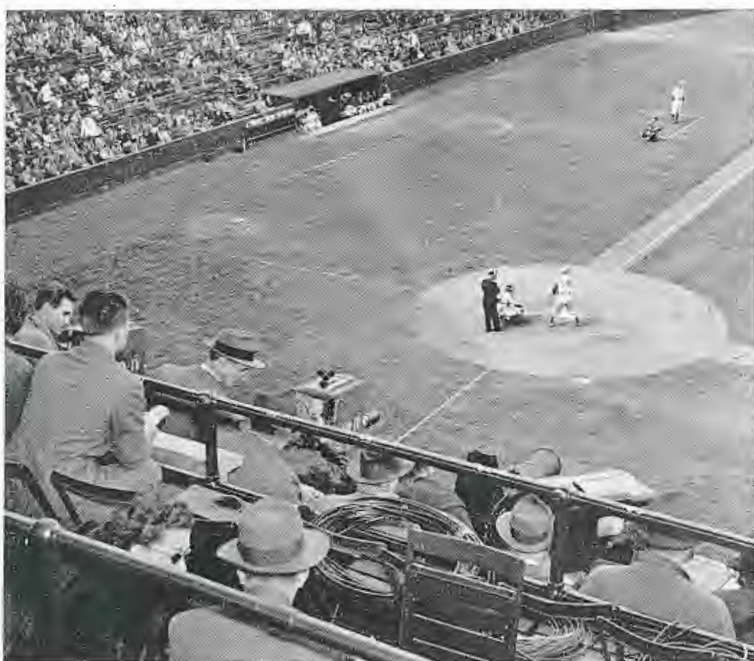

KSD-TV, St. Louis (Cards and Browns) uses two RCA TK-30A Cameras, both of which are located on a special platform (right, above) suspended from the upper deck of the grandstand between first base and homeplate (left, above). KSD-TV started out by using 50MM lenses predominately, but after a few times discarded it because viewers couldn't see enough to hold their interest. Now basic coverage is with a 135MM lens on No. 1, with 14" and 24" telephoto lenses used on No. 2.

KSD-TV's setup differs from the other stations, with the director sitting between, and slightly behind, the two cameras instead of in the control room. Occasionally he takes a look in the view-

finders of one camera or the other, but normally relies on the cameramen to get the shot he requires. By interphone he also calls for the camera he desires on the air.

Camera controls, power supplies and switching unit are located in a truck parked outside the park. Two engineers operate this equipment and are connected by interphone with the director and cameramen. RCA micro-wave relay links send the signal to the transmitter about 2½ miles away. Eight men are used for the pickups—five engineers, including cameramen, two announcers, and one director.



WBKB, Chicago (Cubs) uses two RCA TK-30A Cameras which are located on a ramp suspended from the first balcony on the 3rd base side of homeplate. The location of this ramp is shown in top left view (of the six small pictures above). Relative position of the two cameras is shown in the top center view. The two cameras are about five feet apart and are mounted on the so-called "high-hat" type of semi-fixed mounting. WBKB believes that it is essential that the same viewing angle be maintained (by all cameras), even though a more desirable angle of coverage in specific cases might be obtained.

WBKB's control equipment and announce position are located in the press box about twenty feet to right of the camera position. The view at the top right shows the announcers position, which is to the left of, and immediately adjacent to, the control position. The latter is illustrated in the three lower views. These views are from different angles, but are arranged in the same order as the equipment is actually set up. The view at the left shows the audio position; the center view, the video position, and the righthand view the master, or director's position.



WWDT, Detroit (Tigers) uses two RCA TK-30A Cameras. Both are at the same location, in the lower stands just behind homeplate. Since the pictures above were made, shatter-proof glass has been substituted for the section of the screen which the cameras shoot through. Using two cameras, the 90MM and 135MM lenses are used for general coverage, with the 15" and 17" lens used for closeups.

before the pitch, switch is made to pick up the batter, pitcher, catcher and umpire. If the batter hits, the same camera follows the ball into the outfield. In the meantime, the other camera is picking up a closeup of the fielder about to make the play, with cut to it as the action takes place.

Closeup shot of the batter preparing to hit, occasionally alternating with a closeup of the pitcher, is the primary shot. Just

When a runner is on first or second, a wide-angle shot is used to pick up these bases in addition to the primary coverage of the pitcher's mound and the plate. When bases are loaded, the 90MM lens is used, getting in as much of the diamond as possible.

Actual Pictures From Monitor Screen Showing Field

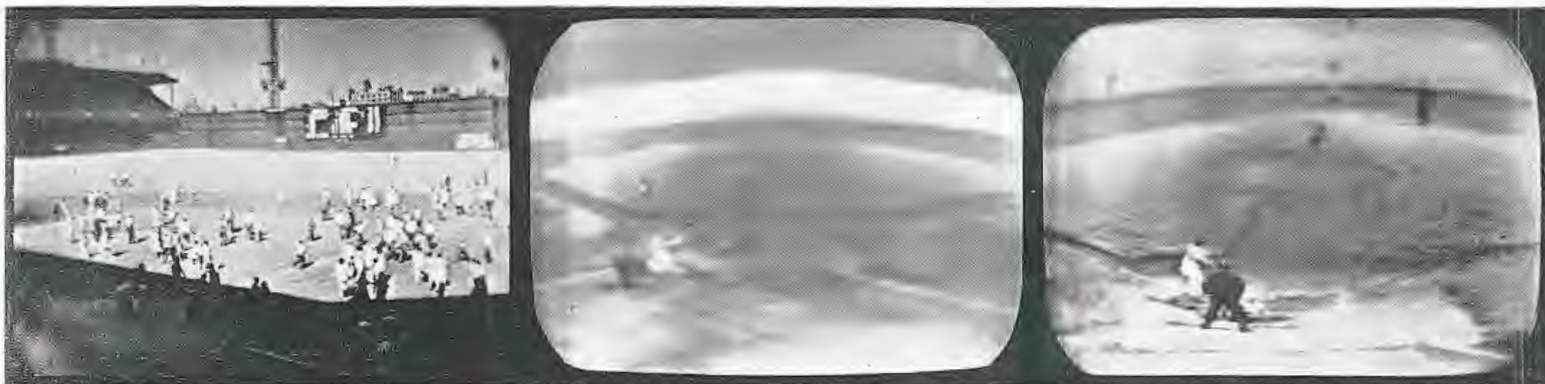

50MM (2") lens was in use when photos at left and center (above) were made. This lens, which has a 34 degree angle, takes in nearly the whole area from 1st to 3rd, with depth sufficient to get everything from plate umpire to the top of the centerfield stand. It is used for before and after the game shots of the entire field and, very occasionally, for action shots when men are on base.

90MM (5") lens field is illustrated in the single picture above. This lens, with its 19 degree angle, picks up the area from second baseman's position to short stop. It is ordinarily used to show pitcher-batter action when there are men on base.



220MM (8½") lens was in use on a camera located in the press box (some 60 feet above ground) when the three photos above were made. This lens, with its 8 degree angle is sometimes used to show the batter coming up to the plate and taking his position (left, above). It is used regularly to show action at the bases

(center, above) as it gives reasonable size figures and still shows some of the surrounding area (including the umpire), which is necessary on fast plays. It is also a favorite for dugout closeups (right, above) and crowd shots, and for this reason is ordinarily used in the No. 2 camera.



430MM (17") lens was in use on No. 2 camera (behind homeplate, 60 feet high) when the three pictures above were made. This lens, with its narrow (4 degree) angle, is used regularly by some stations to provide a closeup of the batter (left, above) on the "3-and-2" pitch. It is used by most stations to

provide closeups of men on base when there is no action (only occasionally for action, as the field is so small). It is used by nearly all stations for closeups of outfield action as it gives reasonable-sized figures and a fair "area of action".

With Various Lens Sizes

NOTE: Pictures used here were selected for subject matter rather than quality. Photographing the television screen, particularly moving figures, is difficult. The small reproductions shown here should not be considered typical of actual pictures as seen on the screen.



135MM lens was being used when the above three photos were made. This lens, which has a 13 degree angle, is the workhorse of baseball television. It has a 10 to 15 foot field width at the plate (depending on distance away), with depth sufficient to take in both homeplate and 2nd base. It provides reasonable size pic-

tures of both batter and pitcher and hence is best-suited for showing pitcher-batter action (left above). As a rule it is also used to "follow-the-ball" on infield plays (center, above). It is sometimes used on the No. 2 camera to pickup a scorecard between innings (right, above) but a 90MM is more often used for this purpose.



330MM (13") lens was in use in No. 1 camera (behind homeplate, 20 feet high) when the three pictures above were made. This lens with its relatively narrow (5 degree) angle is regularly used to show the batter coming up to the plate (left, above). As the batter's figure is approximately full screen

height it is ideal for showing features, stance, etc. This lens is also used alternately (with the 220MM) to show a close-up of the pitcher (center, above). It may be used occasionally for before and after game crowd shots as in the view at right above which is of an exit gate about 380 feet from the camera.

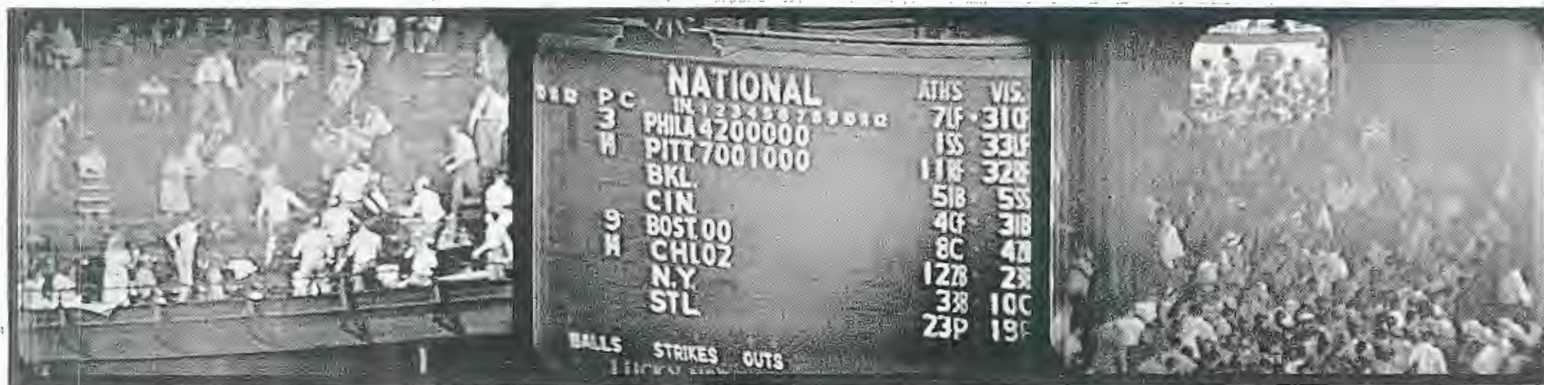

430MM (17") lens was also in use when these three photos were made. This lens is the favorite for closeups of crowds, scoreboards, and "color" shots, as it provides plenty of step up power and yet is not so difficult to pan smoothly as is the big 630MM (25") lens sometimes used for this purpose. The

shot at left, above, shows action in the left field stands at Shibe Park (about 400 feet from the camera) as a home run ball lands there. View at center, above, is of scoreboard on rightfield wall, while that at right, above, shows crowd going through exit gate.

Typical Switching Sequences As Shown By Pictures



INFIELD PLAY (no men on base)

a. Usually starts with closeup of batter coming up and taking position. This view (see above) is made with a 330MM (13") lens on No. 1 camera.

b. Switches to a closeup of the pitcher as the latter starts to wind up. This shot (see above) is made with 430MM (17") lens on No. 2 camera.

c. Just before pitcher delivers switch is made back to camera No. 1 which has shifted to a 130MM (5") lens showing umpire, catcher, batter and pitcher.



OUTFIELD PLAY (no men on base)

a. Either infield or outfield play may start as in line above or as shown here with a closeup of the pitcher made with a 330MM (13") lens on No. 1 camera.

b. Second shot, when this alternate sequence is used, is a medium shot of the batter with a 220MM (8½") lens on No. 2 camera.

c. Meantime No. 1 camera has changed back to 135MM (5") lens and switch is made to the "standard" shot, as shown above.

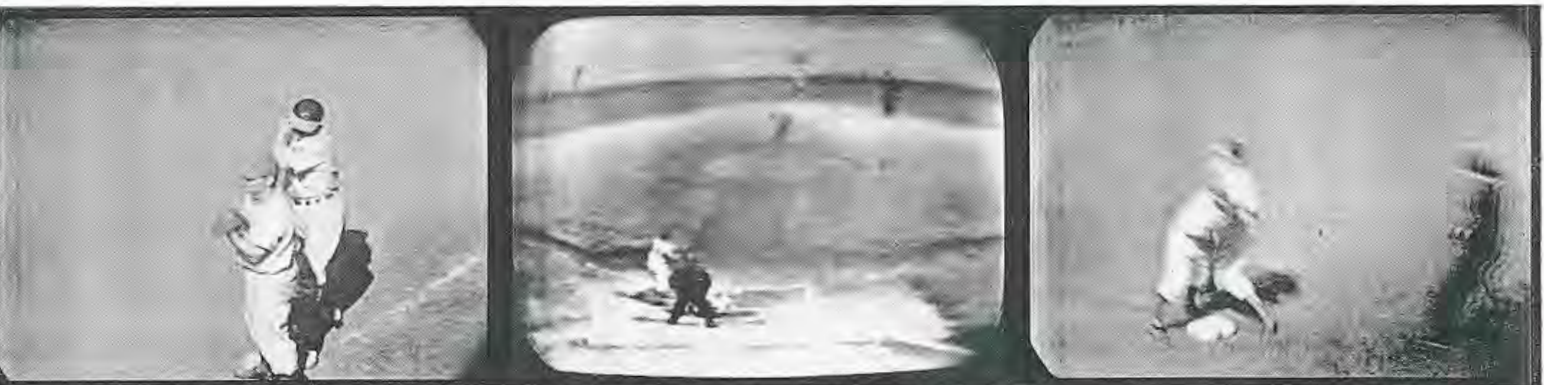

INFIELD PLAY (man on base)

a. With a man on base sequence usually starts with a closeup of the runner on the bag. This is made with 430MM (17") lens on No. 2 camera (see above).

b. Switch is then made to No. 1 camera for batter-pitcher action but in this case most stations use 90MM (3") lens as shown above so that viewers also see runners.

c. In this situation No. 2 camera is instructed to follow the base runner, and thus is ready for action at second on a double play as shown above.

From Monitor Screen

NOTE: These pictures are of WPTZ transmissions. Both WPTZ cameras are behind homeplate. No. 1 camera is about 20 feet high, No. 2 camera about 65 feet high. (See photos, Page 62)

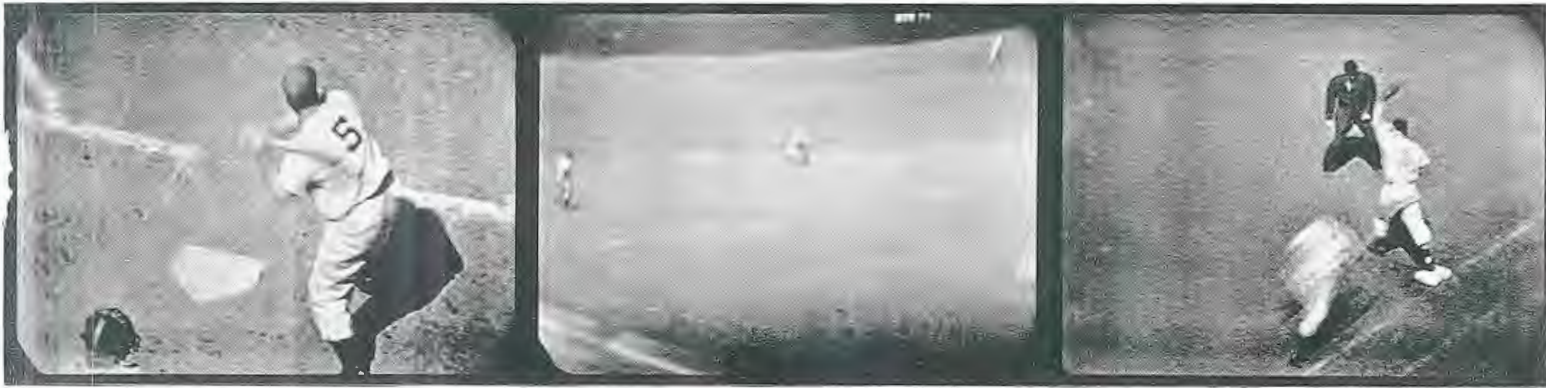

d. In case the count goes to "three and two" some stations switch to this closeup of batter (430MM on No. 2 camera) in order to give good view of crucial pitch.

e. In either case No. 1 camera, with 135MM (5") lens in place "follows the ball" as hit. In the shot above the short stop is shown fielding the ball.

f. After infielder throws ball (and while it is still in the air) switch is made to No. 2 camera which has changed to 220MM (8½") lens to pick up action at first.



d. When the ball is hit to the outfield, switch is made to No. 2 camera which, with 430MM (17") lens, shows closeup of outfielder catching ball.

e. In case of a hit to the outfield, switch is made back to No. 1 camera which, with 135MM (5") lens, shows return of ball to infield (see above).

f. Meantime No. 2 camera has shifted to base where play will be to present closeup with 430MM (17") lens, as shown above.



d. Meantime, No. 1 camera, having followed ball to infielder, then shifts to pick up batter on his way to 1st base (see above).

e. This shows the batter almost down to first. Through this predetermined camera sequence it is possible to pickup the play at both bases even on fast double plays.

f. Following the last out of the inning No. 2 camera using 220MM (8½") lens picks up pitcher walking to dugout and follows him in.



a revolutionary new studio camera

Produces sharp, realistic television pictures
without hot lights

THIS IS IT! RCA's new studio camera which does for indoor productions what RCA's super-sensitive field camera equipment did for outside events! Television pictures produced with this camera are sharp and clear, contain half-tone shadings needed for natural-appearing images, show detail in the highlights and shadows—all without the glare and heat formerly required in television studios.

Gone is the need for expensive, intense studio lighting. No need for oversized air-conditioning plants. You get brilliant, sharply defined pick-ups at light levels of from 100 to 200 foot candles . . . functions down to 25 foot candles.

This studio camera opens new fields of studio production. Is simple to use and requires no fussy shading adjustments. Offers higher resolution and lower noise level than the field-type, image-orthicon camera with somewhat less sensitivity which is not required in the studio. You see exactly what you are picking up on an electronic view finder at the back of the camera.

The turret-mounted lenses can be switched in a matter of seconds. Lens ranges from 35mm f/2.8 to 135mm f/3.8 cover all studio requirements. Depth of focus is such that refocusing is seldom required.

The "eye" of this camera is a new studio-type, image-orthicon tube. Circuits and components used with it are similar to those in RCA's field camera. Therefore, anyone familiar with the field camera can operate or service the studio camera without special training.

The only camera connection needed for operation is a flexible, lightweight cable less than an inch in diameter. Intercommunication facilities for the operator and built-in tally lights are provided to co-ordinate all programming directions.

Here, we believe, is a real aid to versatile, low-cost studio programming . . . brighter, clearer, steadier telecasting. An early order from you will help us meet your delivery requirements. Write Dept. 18-G-2.



STUDIO CAMERA CONTROL—one required for each camera . . . becomes part of video console . . . permits operator to monitor and control quality of picture signal (amplifying, mixing, blanking, synchronizing, etc.).

VIDEO CONSOLE—composed of studio and film camera controls, a master monitor, and switching, lap-dissolve, and fading facilities for selecting the camera pick-up desired. "Building-block" design assures a compact, unified appearance . . . permits adding extra units at any time.



TELEVISION BROADCAST EQUIPMENT
RADIO CORPORATION of AMERICA
ENGINEERING PRODUCTS DEPARTMENT, CAMDEN, N.J.

In Canada: RCA VICTOR Company Limited, Montreal

Already chosen to bring

Deliveries of RCA's 5-kw "All Channel" television transmitter now being made to 21 top stations

Here's the transmitter that is putting television on the map now . . . in many of the nation's key cities.

Announced only four months ago, 21 leading broadcasters have already recognized its design advantages with orders. Four transmitters have already been shipped . . . and it is expected that the others will be shipped this year. The combined radiated power of these stations will blanket approximately 50,000 square miles . . . bring *clear, high-definition* television pictures within reach of 38,143,000 people.

Stage-by-stage, this transmitter has everything you might want for your new station. Here are the highlights:

FINGER-TIP CONTROL for all operating and monitoring functions. Monitoring facilities permit observation of the picture and its waveform. New RCA console handles both sound and picture signals—simplifies getting transmitter on the air and keeping it there.



television to 38,000,000 people

- Covers all 12 metropolitan channels and assures a full 5-kw signal on each channel
- Divides into eight relatively small, lightweight units (25 by 36 by 80 inches) for easy handling and installation and flexible station layout
- Facilitates inspection and servicing with its "walk-in" type construction
- Simplifies transmitter operation due to similarity in design between the sound and picture transmitters
- Eliminates complicated tuning adjustments — a high-level modulation system permits the use of meter-tuned, narrow-band drivers . . . *only one* modulated stage to adjust
- No neutralization of modulated PA stage
- Employs radically new tubes in the output stages — RCA 8D21 twin tetrodes — permitting unusually small r-f drivers
- Requires fewer spare tubes — only 15 types.

From every standpoint, the RCA TT-5A is comparable in convenience, performance, and operating economy with today's finest AM transmitters.

Be sure to get your copy of the new bulletin which fully describes and illustrates its many advantages to the station engineer, manager, owner, and audience. Write Dept. 18-F.

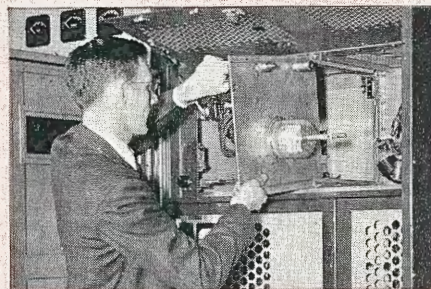
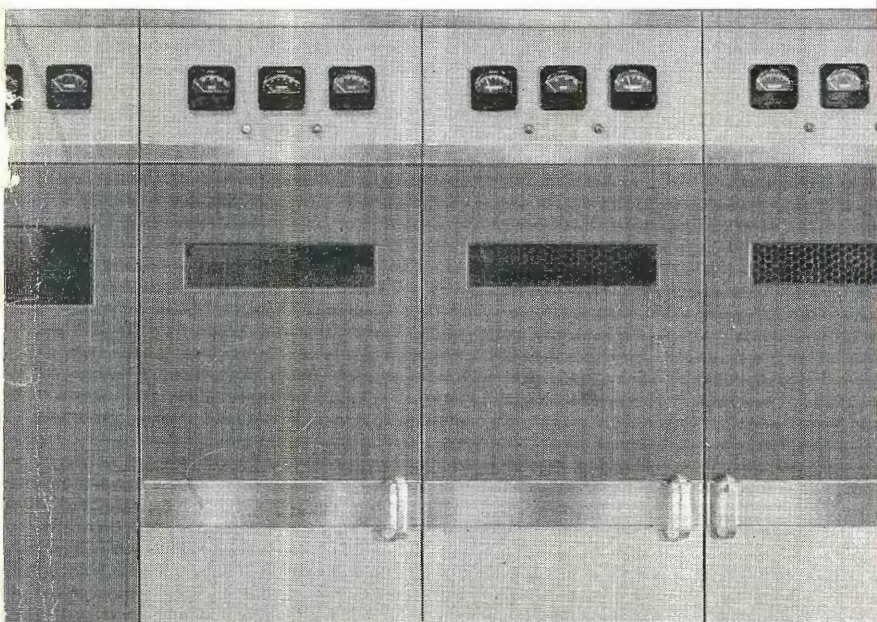

SIMPLIFIED TUBE CHANGING—When a PA tube change is necessary, the tube and special mounting plate can be removed as a unit and a spare assembly slid into place and connected in a matter of minutes.

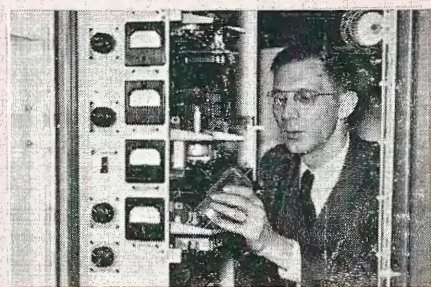

WALL-MOUNTED UNITS afford easy access to all tubes and wiring. Rear doors further increase ease of reaching all components. Illustration above shows portion of the aural transmitter's r-f driver unit.

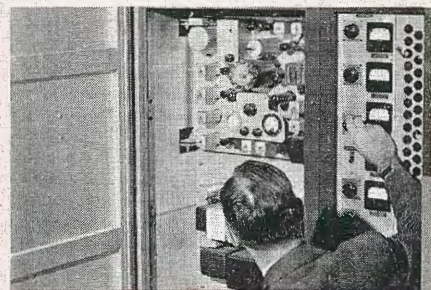

THE "DIRECT FM" EXCITER for the sound channel. Uses only four r-f tubes; does not involve phase multiplication. Inherently capable of lower noise and distortion than any exciter yet developed.



TELEVISION BROADCAST EQUIPMENT
RADIO CORPORATION of AMERICA
ENGINEERING PRODUCTS DEPARTMENT, CAMDEN, N.J.

In Canada: RCA VICTOR Company Limited, Montreal

CONTACT YOUR NEAREST RCA FIELD ENGINEER



R. J. NEWMAN (Dick)
TELEPHONE HEMLOCK 8-300
1335 MARKET ST.
SAN FRANCISCO CAL.

C. LAHAR (Larry)
E. FROST (Jack)
C. W. TURNER (Wes)
TELEPHONE MUTUAL 1103
621 S. HOPE ST.
LOS ANGELES 14, CAL.

W. M. WITTY (Bill)
F. J. KELLEY (Loe)
TEL. RIVERSIDE 1371, 72, 73
1907-11 MCKINNEY AVE.
DALLAS 1, TEXAS

D. BAIN (DAVE)
TELEPHONE HARISON 6933
221 W. 18th ST.
KANSAS CITY 8, MO.

C. M. LEWIS (Buck)
P. H. CLARK (Paul)
E. C. TRACY (Ed)
TEL. DELAWARE 0700
666 N. LAKE SHORE DRIVE
CHICAGO 11, ILLINOIS

P. B. REED (Pinkie)
J. H. KEACHIE (Jim)
G. E. MAKINSON (Grant)
TELEPHONE HERN 3450
718 KETH HERN RD.
CLEVELAND 15, OHIO

J. K. HILER (Ken)
TELEPHONE HUBBARD 0123
280 TREMONT ST.
BOSTON, MASS.

AL. JOSEPHSEN (Al)
H. SADENWATER (Harry)
L. W. HAESELER (Len)
E. MILLER (Eddie)
TEL. COLUMBUS 3-3800
60 W. 49th ST.
NEW YORK 20, N. Y.

F. H. ENGEL
TELEPHONE DISTRICT 1260
1228 ST. N. W.
WASHINGTON 6, D. C.

P. G. WALTERS JR. (P. G.)
R. J. PALMISANO (PUT)
TELEPHONE WALNUT 5946
502 CITIZENS &
SOUTHERN BANK BLDG.
ATLANTA, GEORGIA

AT EACH OF THE LOCATIONS
ABOVE YOU WILL FIND A
BROADCAST SPECIALIST
TO SERVE YOU

WHERE EXPERIENCE COUNTS MOST



AM • FM • TELEVISION